



LED LIGHTING SYSTEM



Owner's Manual

Manuali dei Prodotti

用戶手冊

Bedienungsanleitung

Manual do Proprietário

使用說明書

Mode d'emploi

Instrukcja Obsługi

Dear Customer,

Thank you for purchasing this product.

For optimum performance and safety, please read these instructions carefully.

English

User Memo:

Date of purchase: _____

Dealer name: _____

Dealer address: _____

Dealer website: _____

Dealer email: _____

Dealer phone no.: _____

Please visit us on facebook or twitter!



<https://www.facebook.com/Maxspect>



<http://twitter.com/maxspectled>

Package Content

Please check the content in the package.

English

R5-100

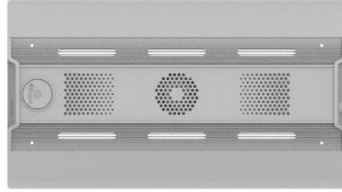

R5-150

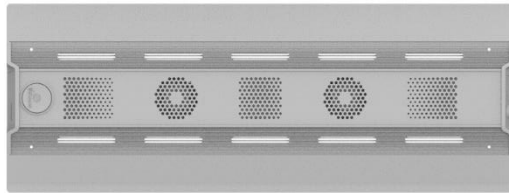

R5-200

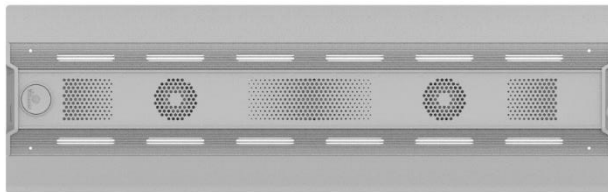

R5-300



Power Supply Unit

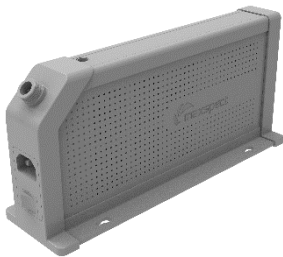

Power Cable



PVC Sticker

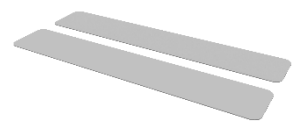

Stands



ThumbScrews

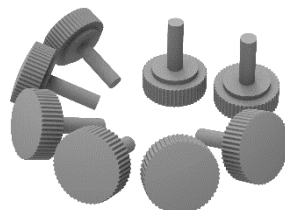

Screws

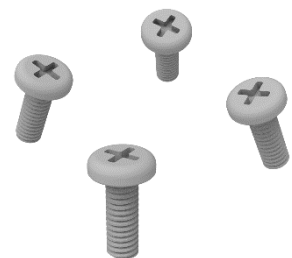

Before using this Maxspect™ RSX LED Lighting System please read these operating instructions carefully. Take special care to follow the safety suggestions listed below.

Afterwards keep this manual handy for future reference.

Before using the Maxspect™ RSX LED Lighting System

1. Remove any plastic bags and packaging material protecting the fixture.
2. Never look directly at the LED bulbs when you switch on the system. Incorrect use of this apparatus will increase eye hazard.

On Safety

1. **Power Source** – Do not defeat the safety purpose of the polarized or grounding-type plug. A polarized plug has two blades with one wider than the other. A grounding-type plug has two blades and a third grounding prong. The wide blade or the third prong are provided for your safety. If the plug does not fit into your outlet, consult an electrician for replacement of the obsolete outlet.
2. **Power Cord Protection** – The power supply cords should be routed so that they are not likely to be walked on or pinched by items placed upon or against them. Never take hold of the plug or cord if your hand is wet, and always grasp the plug body when connecting or disconnecting it.
3. **Installation** – Install indoor only, and use the attachments, mounting frames, hanging kit and accessories provided and specified by the manufacturer.

On Operation

1. **Operation** – Always follow the operation instructions set forth in this manual when using this Maxspect™ RSX LED Lighting System.
2. **Heat** – The apparatus should be situated away from heat sources such as radiators, and do not expose to excessive heat such as sunshine, fire or the like.
3. **Moisture** – To reduce the risk of fire or electric shock, do not expose this apparatus to rain, moisture, dripping or splashing.
4. **Ventilation** – The apparatus should be situated so that its location or position does not interfere with its proper ventilation.
5. **Magnetism** – The apparatus should be situated away from equipment or devices that generate strong magnetism.
6. **Cleaning** – Clean only with dry cloth.

Mounting the RSX LED Lighting System

Before connecting the RSX to the power supply, first mount the system by using the provided stand.

1. Tank-top mounting.

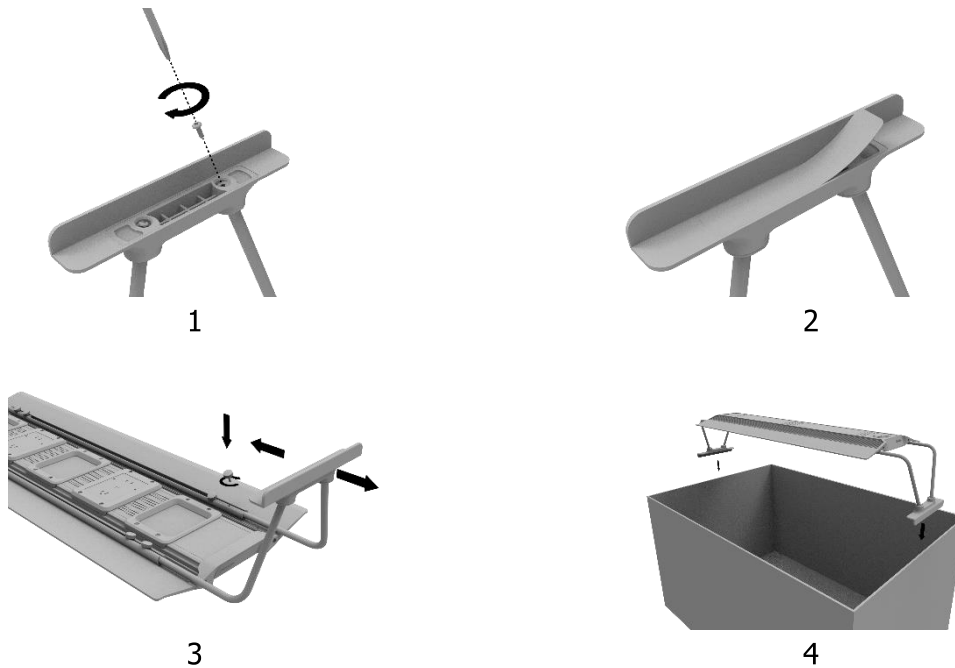

2. Pendant Mounting (hanging Kits sold separately).

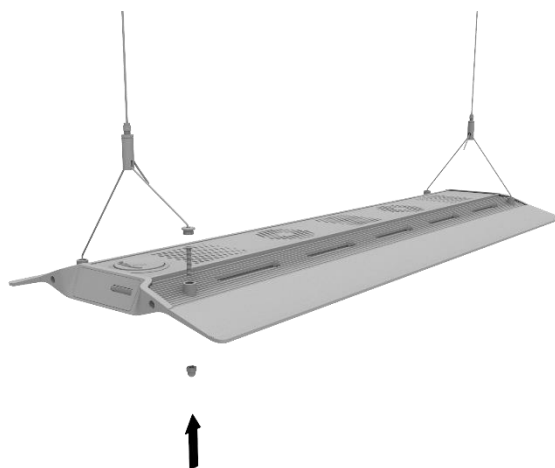

Operating Instructions

English

Built-in Controller

The RSX can be controlled directly with the built-in controller. The built-in controller integrated in the RSX features an OLED monitor and a control dial, from which user can setup all the functions for the fixture.



Standard or Master/Slave Mode

Suppose there are 2 or more units of RSX fixtures, user can connect them together through the Master/Slave mode to control them simultaneously - all Slave fixtures will follow the settings programmed on the Master fixture, saving time and effort on setting up multiple fixtures.

Control with iOS or Android Devices (Optional)

The RSX can also be wirelessly connected to an ICV6 controller (sold separately), which allows the Recuve fixtures to be controlled by iOS or Android devices through the Syna-G System.



Basic Operations

English

Follow the instructions below to operate and program the RSX LED fixture.

The RSX turns on automatically when power is connected, and turns off when power is cut.

When power is resumed, the RSX will restore to the previous saved setting automatically, whether it was last set at Manual or Automatic Mode, and the intensity level of all the LED channels.

The fan on the RSX fixture is temperature controlled.

The RSX has a built-in temperature control system. The fan will be automatically engaged when the temperature is above 55°C/131°F, and disengage when it is below 45°C/113°F.

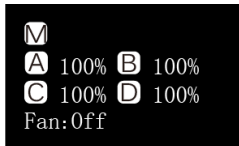

Below 45°C/113°F

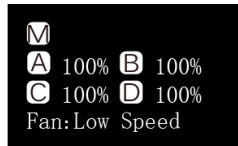

Above 55°C/131°F



Above 65°C/149°F

If the fan fails, the system may overheat and the system will enter fail-safe mode when the temperature is above 80°C/176°F, turning off all channels. The system will exit fail-safe mode and resume normal operation when the temperature drops below 70°C/158°F.

Switching between Auto and Manual Mode

The RSX has two modes of operations: Auto and Manual Mode. User can switch between the two modes with the control dial on the fixture.



- Press and hold the control dial for 3 seconds to switch to another mode.

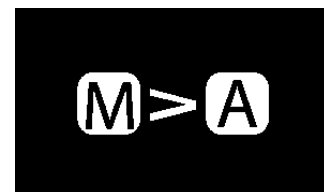

Operating Instructions

English

Manual Mode

- Press the control dial to enter the setting.
- Press the control dial again to switch between the channels.
- Rotate the control dial to set the brightness for each LED channel.
- Press and hold the control dial for 3s to save the setting and exit the page.



Automatic Mode

- Press the control dial to enter the setting.
- Rotate the control dial to switch between the settings.
- Press and hold the control dial for 3s to save the setting and exit the page.

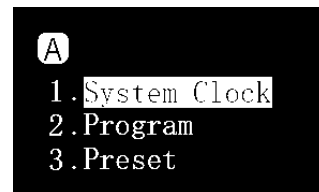
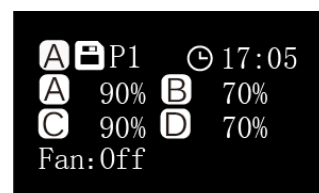

Within Automatic Mode, there are 3 settings for user to select:

System Clock: A clock set to be matched with users' local time.

Program: Program the photoperiod to set specific brightness for each LED channel during different time of the day.

Preset: 4 preset settings are available for user to choose from. (Refer to p.16)

P1: SPS dominated tank.

P2: SPS/LPS mixed tank.

P3: Soft Coral/LPS mixed tank.

P4: SPS dominated tank with a different dawn/dusk time with moon light.

Setting the clock

- Press the control dial to enter the setting page and then select "System Clock".
- Press the control dial to switch between hour and minute.
- Rotate the control dial to set the time.
- Press and hold the control dial for 3s to save the setting and exit the page.

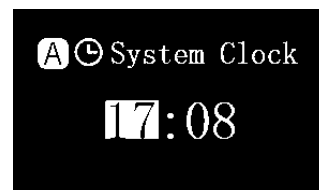
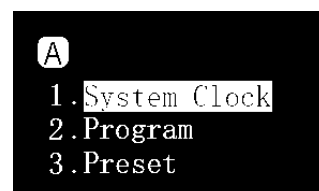

Understanding Time Points

English

There are a total of 24 Time Points. You can program different luminous output intensity at each Time Point to control the photoperiod and brightness of the system.

Take Preset P1 as an example, it is a setting for SPS dominated tank. The photoperiod starts at 08:00 where the system increases light gradually, peaks at 10:00 and lasts 10hrs to 20:00 before the system gradually decreases light until it is turned off at 22:00, with moon light turns on.

	TP01	TP02	TP03	TP04	TP05	TP06	TP07	TP08
	08:00	09:00	10:00	20:00	20:30	21:00	21:30	22:00
Channel A	0%	40%	90%	90%	70%	50%	25%	0%
Channel B	0%	20%	70%	70%	30%	15%	10%	0%
Channel C	1%	20%	70%	70%	30%	15%	10%	1%
Channel D	0%	20%	90%	90%	30%	15%	10%	0%

The following diagram illustrates how the 4 LED channels would behave once the above Time Points have been programmed.

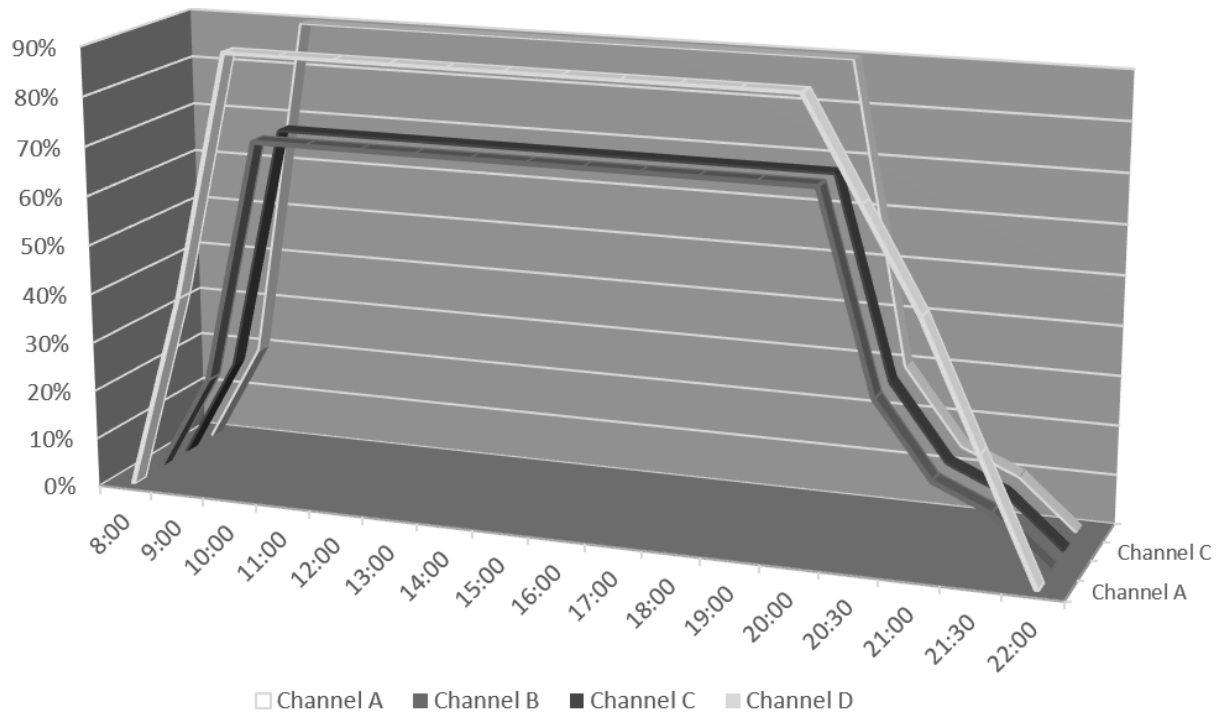

Operating Instructions

English

Programming Photoperiod

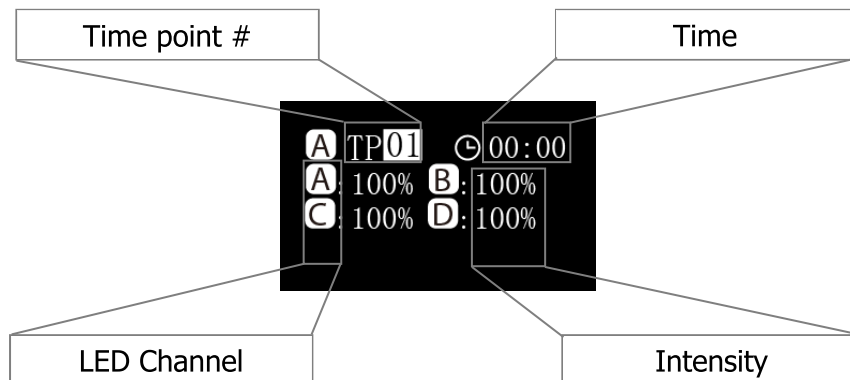

Modify

- Press the control dial to switch between the parameters.
- Rotate the control dial to set the parameter.
- Press and hold the control dial for 3s to turn to the next page.

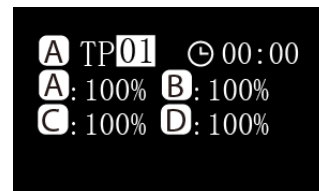

Apply

- Rotate the control dial to select "Apply".
- Press the control dial to save the setting.
- Press and hold the control dial for 3s to return to the main menu.



Preview

- Rotate the control dial to select "Preview".
- Press the control dial to runs the program in preview mode, where the entire photoperiod is demonstrated in 3 minutes.
- Press and hold the control dial for 3s to return to the main menu.



- Rotate the control dial to select "Modify".
- Press the control dial to readjust the parameters, see "Modify" above.



Selecting Preset

English

- Rotate the control dial to switch between the presets.
- Press the control dial to turn to the next page.

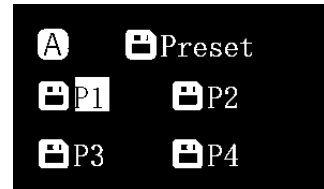

Apply

- Rotate the control dial to select "Apply".
- Press the control dial to save the setting.



Preview

- Rotate the control dial to select "Preview".
- Press the control dial to runs the program in preview mode, where the entire preset is demonstrated in 3 minutes.
- Press and hold the control dial for 3s to return to the main menu.



- Rotate the control dial to select "Exit".
- Press the control dial to go back to the main menu.



Maintenance Instructions

English

System Setup

System Setup features a set of functions allowing user to do perform maintenance on the fixture.

To enter the System Setup page, first turn off the fixture, then press and hold the control dial while turning the fixture back on. Keep on holding the control dial until the system setup page is shown on OLED monitor.

There are 7 functions in the System Setup screen.

1. Firmware
2. Restore
3. Reset
4. Test Mode
5. Model Number
6. Standard or Master/Slave mode
7. Exit

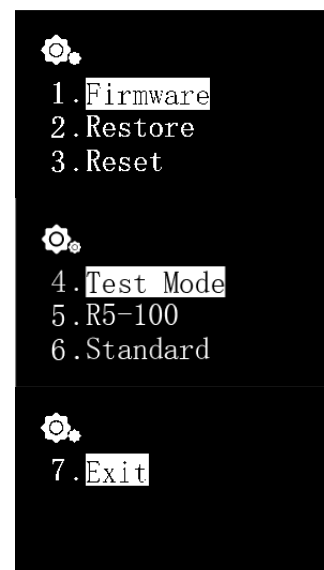

1. Firmware

This function allows the user to update the firmware.

- Rotate the control dial to select "Firmware".
 - Press the control dial to begin the firmware update.
-
- When there is no TF (micro SD) card or invalid firmware in the TF card, "NO TF Card" or "Wrong File" will be shown.
 - Otherwise the firmware update progress will be shown.
-
- Once the firmware has been updated successfully, the fixture will restart automatically and the new firmware version number will be shown.

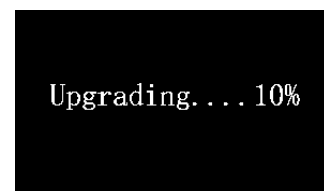

2. Restore

This function allows the user to restore the firmware to its original factory version. After finish restoring the firmware, the fixture will restart automatically and the firmware version number will be shown.

- Rotate the control dial to select "Restore".
- Press the control dial to restore the firmware.



3. Reset

This function allows the user to reset the fixture back to its factory settings. After finish resetting the fixture, it'll restart automatically.

- Rotate the control dial to select "Reset".
- Press the control dial to factory reset the fixture.



4. Test Mode

This function allows the user to put the fixture in the test mode, which would help our customer service representative to diagnose the fixture. **This should only be done by the users when told by authorized dealer or customer representative to perform certain test on the fixture.**

5. Model Number

This function will display the model number of the fixture, which also double serves as the ID name when the RSX is connected to an iOS or Android device through the Syna-G system. **Under normal circumstances this value should not be changed.**

Maintenance Instructions

English

6. Standard or Master/Slave Mode

This function allows the user to choose between the Standard stand-alone operation mode, or Master/Slave mode where multiple units of RSX fixtures can be connected together.

Once connected, all Slave fixtures will follow the settings programmed on the Master fixture, saving time and effort on setting up multiple fixtures.

The default value is "Standard" meaning the fixture is running in stand-alone operation mode.

When a RSX is set as Master Unit, it will need to assign a channel from 01 to 10. All connecting Slave Units must be also assigned to the same channel.

In case where multiple groups of Master/Slave coexist in a proximity, each Master Unit must assign a different channel to avoid interference with another group.

- Rotate the control dial to select "Standard".
- Press the control dial to enter the setting page.
- Rotate the control dial to assign it as a "Master" or "Slave" unit.
- After selecting Master/Slave unit, press the control dial to assign a channel.
- Press and hold the control dial for 3s to save the setting.

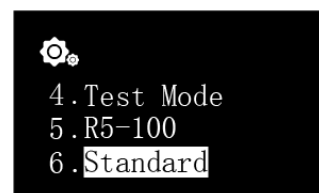

7. Exit

- Press "Exit" to restart the fixture.

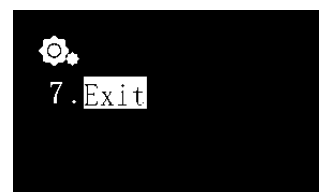

Maintenance of the fixture

User must periodically perform maintenance on the fixture, including but not limited to the following steps:

- Using a damp cloth to clean the acrylic lens to make sure it's not covered by salt creep or other dirt and debris. Uncleaned lens will severely affect the luminous output of the fixture, so for best performance you should clean the lens once a week.
- Clean the dust and debris trapped in the fan units. Regularly and properly cleaned fans will last much longer than those that aren't. Fan units are wear-and-tear parts and must be replaced every 24-36 months depends on the frequency of maintenance performed on them.
- Clean / remove any salt creep or dirt and debris that had been builtup or collected on the aluminum body of the fixture, as they may affect the dissipation of heat from the fixture.

Note: Failure to perform the above mentioned maintenance on the fixture may cause unnecessary damage to your fixture and may void your warranty!

Specifications

For latest specifications on LED layout, types and color spectrum, please visit our website at: www.maxspect.com



Limited Warranty

English

Maxspect (HongKong) Limited warrants all Maxspect™ RSX LED Lighting System products against defects in workmanship for a period of 12-months from the date of purchase. If a defect exists during the warranty period, Maxspect (HongKong) Limited at its option will either repair (using new or remanufactured parts) or replace (with a new or remanufactured unit) the product at no charge.

THE WARRANTY WILL NOT APPLY TO THE PRODUCT IF IT HAS BEEN DAMAGED BY MISUSE, ALTERATION, ACCIDENT, IMPROPER HANDLING OR OPERATION, OR IF UNAUTHORIZED REPAIRS ARE ATTEMPTED OR MADE. SOME EXAMPLES OF DAMAGES NOT COVERED BY WARRANTY INCLUDE, BUT ARE NOT LIMITED TO, USING AFTER-MARKET LED BULBS AND MODIFICATION OF THE CIRCUITRY, WHICH ARE PRESUMED TO BE DAMAGES RESULTING FROM MISUSE OR ABUSE.

DISCLAIMER OF CONSEQUENTIAL AND INCIDENTAL DAMAGES:

You and any other user of Maxspect (HongKong) Limited products shall not be entitled to any consequential or incidental damages, including without limitation, loss of use of the unit, inconvenience, damage to personal property, phone calls, lost income or earnings. This warranty gives you specific legal rights and you may also have other rights, which vary from state to state.

MAXSPECT LTD. MAKES NO WARRANTY OR REPRESENTATION, EITHER EXPRESS OR IMPLIED, WITH RESPECT TO THE PRODUCT'S QUALITY, PERFORMANCE, MERCHANTABILITY, OR FITNESS FOR A PARTICULAR PURPOSE. AS A RESULT, THIS PRODUCT, IS SOLD "AS IS," AND YOU THE PURCHASER ASSUME THE ENTIRE RISK AS TO ITS QUALITY AND PERFORMANCE.

IN NO EVENT WILL MAXSPECT LTD BE LIABLE FOR DIRECT, INDIRECT, SPECIAL, INCIDENTAL, OR CONSEQUENTIAL DAMAGES RESULTING FROM ANY DEFECT IN THE PRODUCT OR ITS DOCUMENTATION.

The warranty, disclaimer, and remedies set forth above are exclusive and replace all others, oral or written, expressed or implied. At no time will any Maxspect (HongKong) Limited dealers, agents, or employees be authorized to make any modifications, extension, or addition to this warranty.

Some states do not allow the exclusion or limitation of implied warranties or liability for incidental or consequential damages, so the above limitation or exclusion may not apply to you.

English

Preset 1

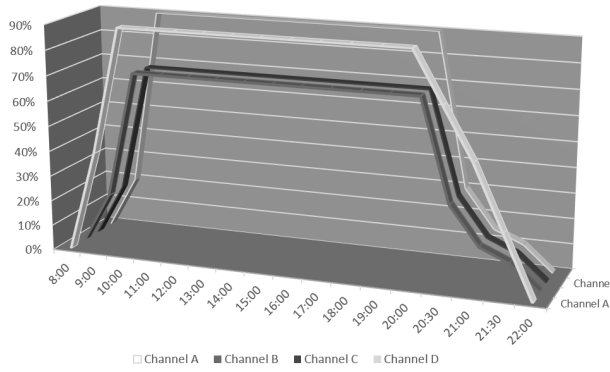

Preset 2

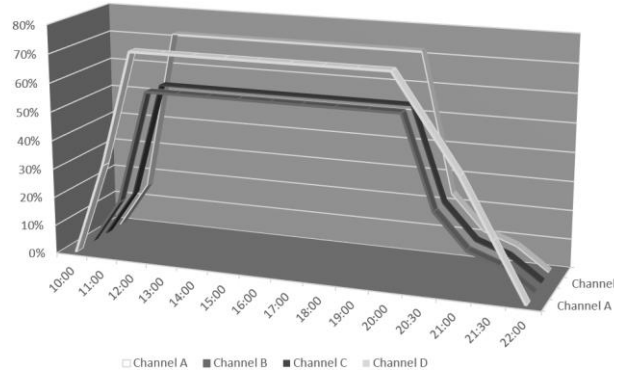

Preset 3

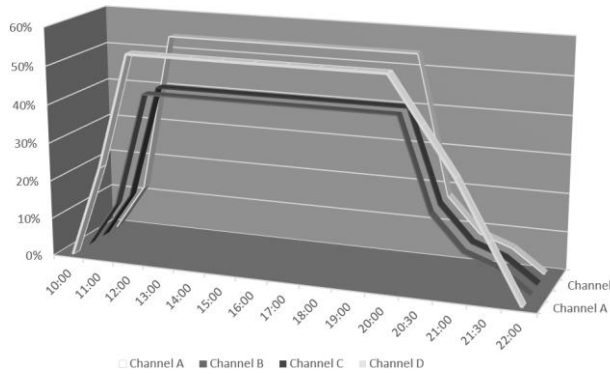

Preset 4

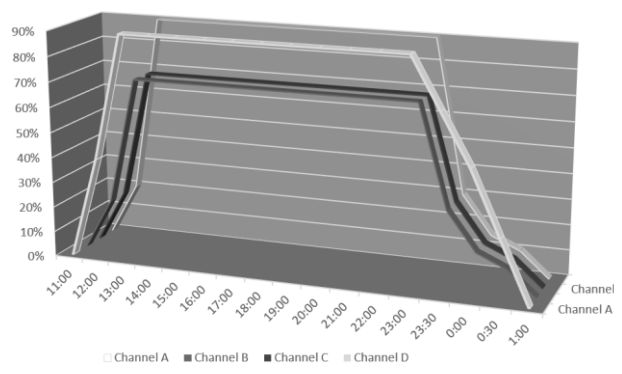

Sehr geehrter Kunde,

vielen Dank für den Kauf dieses Produkts.

Für eine optimale Leistung und Sicherheit, lesen Sie bitte diese Anleitung sorgfältig.

Nutzer-Memo:

Kaufdatum

Händler:

Händleradresse:

Händlerwebsite:

Händler-E-Mail:

Händlertelefon

Deutsch

Bitte besuchen Sie uns auf Facebook oder Twitter!



<https://www.facebook.com/Maxspect>



<http://twitter.com/maxspectled>

Bitte überprüfen Sie den Lieferumfang auf Vollständigkeit.

Deutsch

R5-100

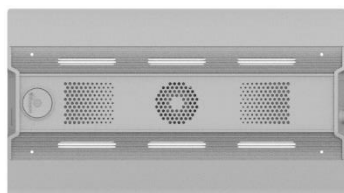

R5-150

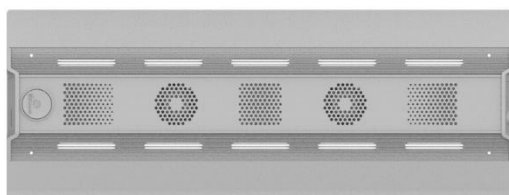

R5-200

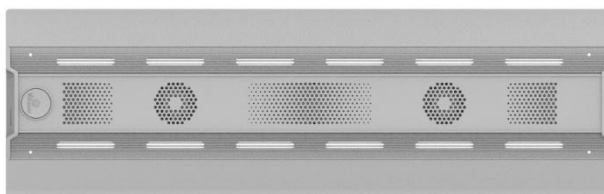

R5-300



Netzteil

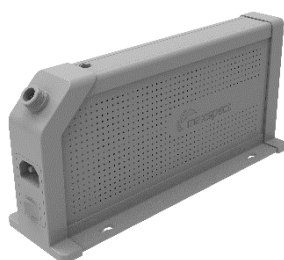

Stromkabel



PVC Aufkleber

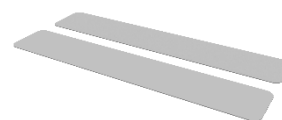

Aufsetzsystem



Handschrauben

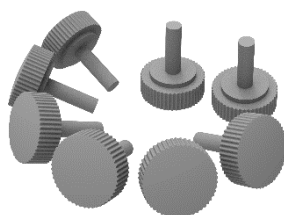

Schraube

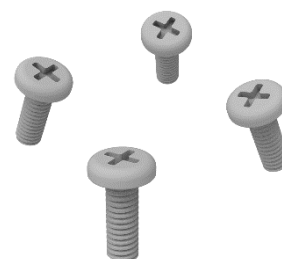

Vor der ersten Inbetriebnahme des Maxspect™ LED-Beleuchtungssystems RSX sollten Sie diese Bedienungsanleitung sorgfältig lesen. Bitte beachten Sie die folgenden Sicherheitshinweise mit großer Sorgfalt. Bewahren Sie diese Anleitung auch zum späteren Nachschlagen auf.

Vor der Benutzung des Maxspect™ RSX LED-Beleuchtungssystems

3. Falls vorhanden, entfernen Sie vor der Benutzung alle Schutzfolien.
4. Schauen Sie nie direkt in die LED-Leuchten wenn Sie das System einschalten. Die unsachgemäße Nutzung dieses Geräts kann eine Gefahr für die Augen bedeuten.

Zur Sicherheit

1. **Stromquelle** – Setzen Sie die sicherheitsrelevanten Merkmale eines gepolten oder eines geerdeten Steckers nicht außer Kraft. Ein geerdeter Stecker verfügt über zwei Stifte und über einen dritten Erdungsstift. Der Erdungsstift ist zu Ihrer Sicherheit vorhanden. Sollte der Stecker nicht in Ihre Steckdose passen, kontaktieren Sie einen Elektriker, um die veraltete Dose austauschen zu lassen.
2. **Netzkabel** – Die Netzkabel sollten so verlegt werden, dass man nicht darüber steigen muss und sie auch nicht von Gegenständen beschädigt werden können, die unter oder neben den Kabeln liegen. Fassen Sie den Stecker oder das Kabel nie mit nassen Händen an und greifen Sie den Stecker beim Einstecken oder Abziehen immer direkt an.
3. **Installation** – Nur im Innenbereich benutzen und verwenden Sie nur die vom Hersteller mitgelieferten Zubehörteile, Befestigungsrahmen und Aufhängensysteme.

Zum Betrieb

1. **Bedienung** – Befolgen Sie immer die Bedienungshinweise dieses Handbuchs, wenn Sie das RSX LED-Beleuchtungssystem nutzen.
2. **Hitze** – Das Gerät sollte fern von Wärmequellen, wie zum Beispiel Heizkörpern, aufgestellt werden und darf keiner großen Hitze, wie etwa Sonneneinstrahlung oder Feuer, ausgesetzt werden.
3. **Feuchtigkeit** – Zur Verringerung der Stromschlaggefahr darf das Gerät nicht mit Regen, Feuchtigkeit, Tropf- und Spritzwasser in Kontakt kommen.
4. **Belüftung** – Das Gerät sollte so aufgestellt werden, dass Standort und Position die Belüftung des Geräts nicht beeinträchtigen.
5. **Magnetismus** – Das Gerät sollte fern von Anlagen oder Geräten aufgestellt werden, die starken Magnetismus erzeugen.
6. **Reinigung** – Reinigen Sie das Gerät nur mit einem trockenen Tuch.

Montieren des RSX LED-Beleuchtungssystems

Bevor Sie die LED-Module mit dem Steuergerät verbinden, montieren Sie zunächst das System mit Hilfe des Aufsetzsystems.

1. Aquariumaustellung

Deutsch

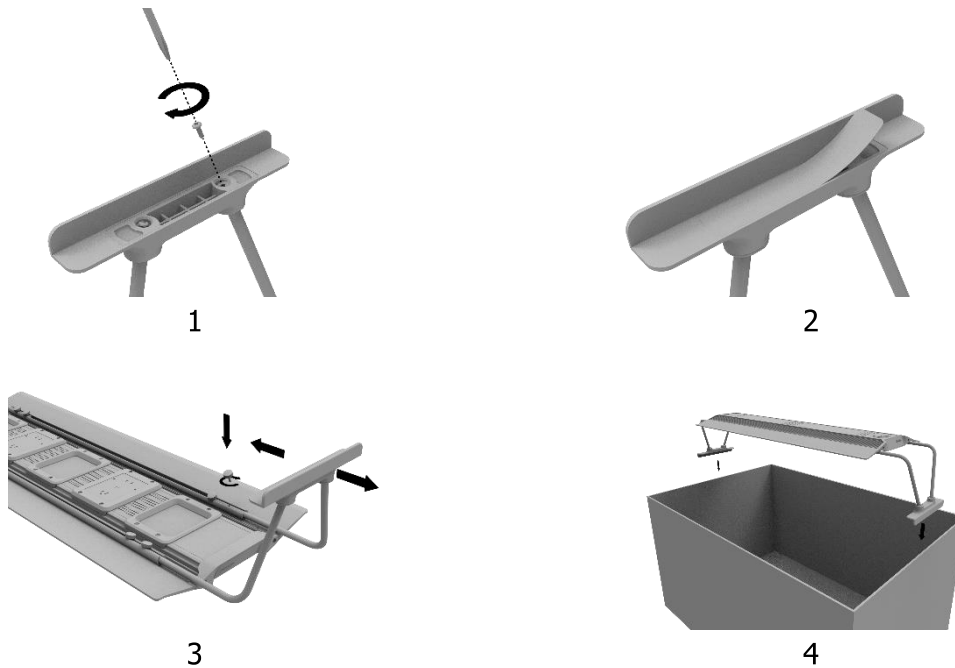

2. Deckenbefestigung (Seilset optional erhältlich)

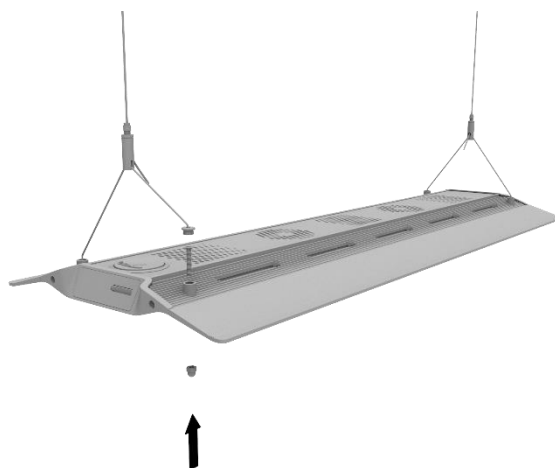

Eingebauter Controller

Die RSX kann mit dem integrierten Controller gesteuert werden. Sie hat einen OLED-Display und ein Einstellrad mit denen der Benutzer alle Funktionen der RSX sofort einstellen kann.



Deutsch

Standard- oder Master / Slave-Modus

Ab 2 oder mehr RSX Einheiten, kann der Benutzer die Leuchten über den Master / Slave-Modus miteinander verbinden und gleichzeitig programmieren. Alle Slave-Einheiten übernehmen dann die Einstellungen von der Master-RSX und der Benutzer spart somit Zeit und Mühe bei Verwendung von mehreren Einheiten.

Steuerung mit iOS- oder Android-Geräten (optional)

The RSX can also be wirelessly connected to an ICV6 controller (sold separately), which allows the Recuve fixtures to be controlled by iOS or Android devices through the Syna-G System.



Benutzung

Befolgen Sie die nachstehenden Anweisungen um die Maxspect RSX in Betrieb zu nehmen.

Sobald Die RSX an das Stromnetz angeschlossen wird schaltet sie sich automatisch ein, und schaltet sich aus, wenn sie vom Stromnetz getrennt wird

Wenn die Stromversorgung wieder eingeschaltet wird, kehrt die RSX auf die früheren automatisch gespeicherten Einstellungen wieder zurück.

Der Lüfter der RSX-Leuchte ist temperaturgesteuert.

Die RSX hat ein integriertes Temperaturregelsystem. Der Lüfter schaltet sich automatisch ein wenn die Temperatur über 55°C liegt und schaltet sich aus wenn die Temperatur unter 45°C fällt.

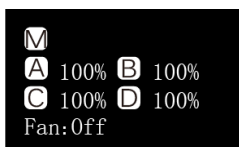

Unter 45°C/113°F

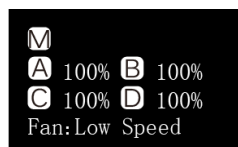

Über 55°C/131°F

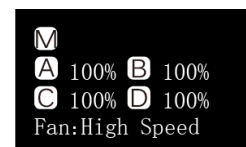

Über 65°C/149°F

Würde der Lüfter ausfallen, könnte die Leuchte überhitzen. Doch dank seinem Schutzsystem, wird die RSX automatisch ausgeschaltet, wenn die Temperatur über 80°C liegt. Sobald die Temperatur unter 70°C absinkt, schaltet sich die Leuchte wieder ein und setzt den normalen Betrieb weiter.

Umschalten zwischen Auto und Manuell-Modus.

Die RSX verfügt über 2 Betriebsarten: Auto und Manuell-Modus. Der Benutzer kann zwischen den beiden Modi mit dem Einstellrad auswählen.



- Den Drehregler 3 Sekunden lang gedrückt halten um von einem Modus zum anderen zu wechseln.

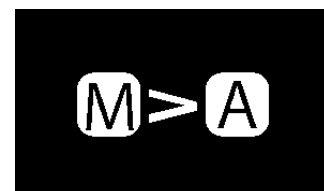

Manueller Modus

- Drücken Sie den Drehregler um zur Einstellung zu gelangen
- Drücken Sie erneut den Drehregler, um zwischen den Kanälen zu wählen.
- Drehen Sie den Drehregler um die Helligkeit für jeden LED-Kanal einzustellen.
- Den Drehregler 3 Sek. lang gedrückt halten um die Einstellung speichern und zu verlassen.

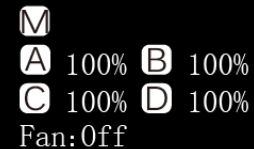

M
 A 100% B 100%
 C 100% D 100%
 Fan: Off

Deutsch

Automatischer Modus

- Drücken Sie den Drehregler um zur Einstellung zu gelangen
- Mit dem Drehregler zwischen den Einstellungen wechseln.
- Den Drehregler 3 Sek. lang gedrückt halten um die Einstellung speichern und zu verlassen.

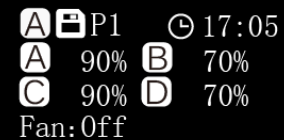

A P1 17:05
 A 90% B 70%
 C 90% D 70%
 Fan: Off

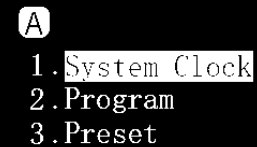

A
 1. System Clock
 2. Program
 3. Preset

Innerhalb des automatischen Modus gibt es 3 Einstellungen für den Benutzer:

System Clock: für die Einstellung auf die Ortszeit des Benutzers.

Program: Zum Programmieren der Photoperiode und Einstellung der Helligkeit von jedem LED-Kanal für die verschiedenen Stunden des Tages.

Preset: 4 Voreinstellungen stehen für den Benutzer zur Auswahl. (Siehe Seite 32)

P1: Für Aquarien mit überwiegend SPS-Korallen.

P2: Für Aquarien mit SPS und LPS.

P3: Für Aquarien mit Weich- und LP- Korallen

P4: Für Aquarium mit SPS-Korallen und einer anderen Morgen- und Abenddämmerungszeit und mit Mondlicht.

Einstellung der Uhrzeit

- Das Einstellrad drücken um die Einstellungsseite aufzurufen und dann "System Clock" auszuwählen.
- Das Einstellrad drücken um zwischen Stunde und Minute zu wechseln.
- Drehen Sie das Einstellrad um die Zeit einzustellen.
- Den Drehregler 3 Sek. lang gedrückt halten um die Einstellung speichern und zu verlassen.

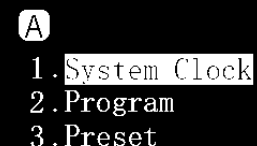

A
 1. System Clock
 2. Program
 3. Preset



A System Clock
 17:08

Zeitpunkte verstehen

Es gibt insgesamt 24 Zeitpunkte. Sie können zu jedem Zeitpunkt eine unterschiedliche Lichtausgangsintensität programmieren, um die Photoperiode und die Helligkeit des Systems zu steuern.

Deutsch

Nehmen wir Preset P1 als Beispiel, es ist eine Einstellung für Aquarien mit überwiegend SPS-Korallen. Die Beleuchtungsperiode beginnt um 8:00 Uhr und die Lichtintensität nimmt stufenweise zu, mit einem Pick um 10.00 Uhr der bis 20.00 Uhr dauert. Danach nimmt die Lichtintensität stufenweise bis um 22:00 Uhr ab und das Mondlicht schaltet sich ein.

	TP01	TP02	TP03	TP04	TP05	TP06	TP07	TP08
	08:00	09:00	10:00	20:00	20:30	21:00	21:30	22:00
Kanal A	0%	40%	90%	90%	70%	50%	25%	0%
Kanal B	0%	20%	70%	70%	30%	15%	10%	0%
Kanal C	1%	20%	70%	70%	30%	15%	10%	1%
Kanal D	0%	20%	90%	90%	30%	15%	10%	0%

Das folgende Diagramm zeigt, wie sich die 4 LED-Kanäle verhalten, sobald die Zeitpunkte von oben programmiert sind.

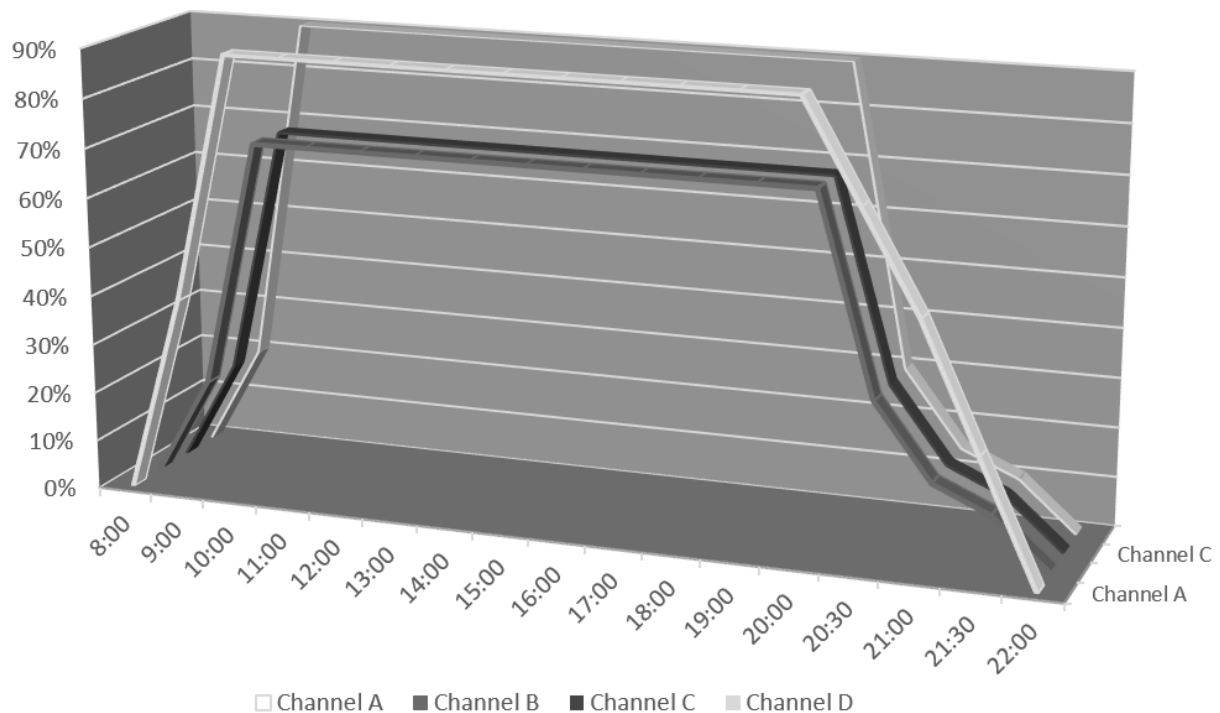

Photoperiode Programmierung

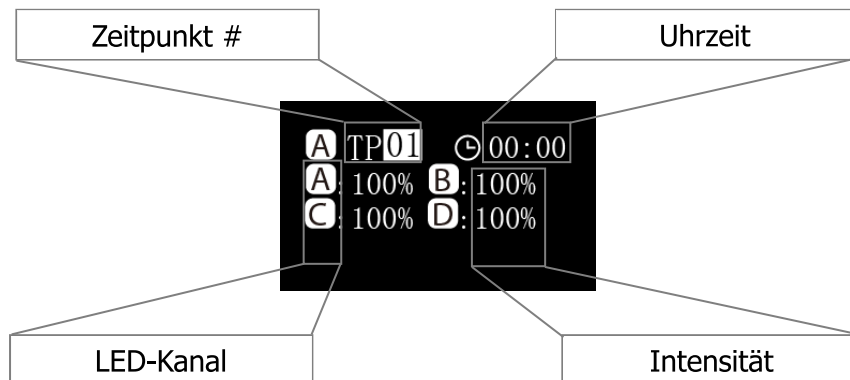

Deutsch

Änderung

- Das Einstellrad drücken um zwischen den Einstellungen zu wechseln.
- Drehen Sie das Einstellrad um die Einstellungen festzulegen.
- Das Einstellrad 3s lang gedrückt halten um zur nächsten Seite zu gelangen.

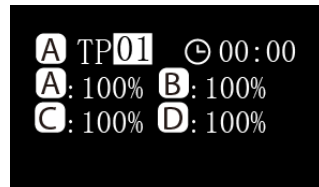

Bestätigen

- Drehen Sie das Einstellrad um "Apply" auszuwählen.
- Drücken Sie das Einstellrad, um die Einstellung zu speichern.
- Das Einstellrad 3s lang gedrückt halten um zum Hauptmenü zurückzukehren.



Vorschau

- Drehen Sie das Einstellrad um "Preview" auszuwählen.
 - Drücken Sie das Einstellrad um das Programm im Vorschaumodus auszuführen. Die gesamte Photoperiode wird in 3 Minuten dargestellt.
 - Das Einstellrad 3s lang gedrückt halten um zum Hauptmenü zurückzukehren.
- Drehen Sie das Einstellrad, um "Modify" auszuwählen.
 - Erneut drücken um die Einstellungen abändern. Siehe "Ändern" oben.

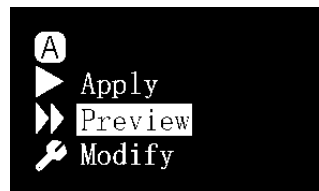

Voreinstellungen auswählen

- Drehen Sie das Einstellrad um zwischen den Voreinstellungen auszuwählen.
- Drücken Sie das Einstellrad um zur nächsten Seite zu wechseln.

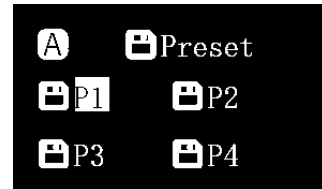

Bestätigen

- Drehen Sie das Einstellrad um "Apply" auszuwählen.
- Drücken Sie das Einstellrad, um die Einstellung zu speichern.



Vorschau

- Drehen Sie das Einstellrad um "Preview" auszuwählen.
- Drücken Sie das Einstellrad um das Programm im Vorschaumodus auszuführen. Das gesamte Presetprogramm wird in 3 Minuten dargestellt.
- Das Einstellrad 3s lang gedrückt halten um zum Hauptmenü zurückzukehren.



- Drehen Sie das Einstellrad um "Exit" auszuwählen.
- Drücken Sie das Einstellrad um zum Hauptmenü zurückzukehren.



Systemeinrichtung

Das Systemeinrichtungsmenu verfügt über eine Reihe von Funktionen, die es dem Benutzer ermöglichen, die Wartung des Gerätes durchzuführen.

Um das Systemeinrichtungsmenu aufzurufen, schalten Sie zuerst die Leuchte aus und drücken Sie dann auf das Einstellrad, während Sie das Gerät wieder einschalten. Halten Sie das Einstellrad so lange gedrückt, bis das Systemeinrichtungsmenu auf dem OLED-Monitor angezeigt wird.

Deutsch

Es gibt 7 Funktionen im Systemeinrichtungsmenu.

1. Firmware
2. Wiederherstellen
3. Rücksetzen
4. Testmodus
5. Modellnummer
6. Standard- oder Master / Slave-Modus
7. Verlassen

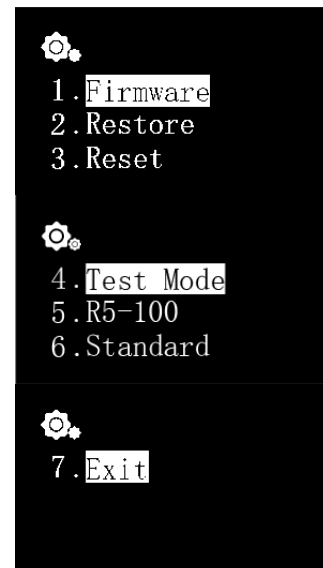

1. Firmware

Mit dieser Funktion kann der Benutzer die Firmware aktualisieren.

- Drehen Sie das Einstellrad um "Firmware" auszuwählen.
- Drücken Sie auf das Einstellrad, um die Firmware-Aktualisierung zu beginnen.
- Wenn keine TF(micro SD)-Karte erkannt wird oder eine ungültige Firmware in der TF-Karte ist, wird "NO TF-Karte" oder "Wrong File" angezeigt.
- Andernfalls wird das Firmware-Update-Fortschritt angezeigt.
- Sobald die Firmware-Aktualisierung erfolgreich war, wird das Gerät automatisch neu gestartet und die neue Firmware-Versionsnummer wird angezeigt.

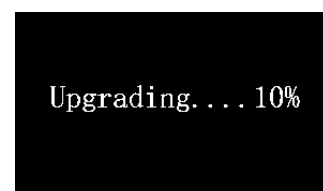

2. Wiederherstellen

Mit dieser Funktion kann der Benutzer die Firmware auf die Werkseinstellung wieder zurückstellen. Nach Wiederherstellung der Firmware wird das Gerät automatisch neu gestartet und die Firmware-Versionsnummer wird angezeigt.

- Drehen Sie das Einstellrad, um "Restore" auszuwählen.
- Drücken Sie das Einstellrad, um die Firmware wiederherzustellen.



3. Rücksetzen

Diese Funktion ermöglicht es dem Benutzer, das Gerät wieder auf die Werkseinstellungen zurückzusetzen. Nach dem Zurücksetzen wird das Gerät automatisch neu gestartet.

- Drehen Sie das Einstellrad um "Reset" auszuwählen.
- Drücken Sie auf das Einstellrad um das Gerät auf die Werkseinstellungen zurückzusetzen.



4. Testmodus

Diese Funktion ermöglicht es dem Benutzer das Gerät in den Testmodus zu bringen um unserem Kundendienst zu helfen eine Diagnose von dem Gerät zu machen. **Dies sollte nur erfolgen, wenn ein autorisierter Fachhändler es von dem Benutzer verlangt, um einen bestimmten Test auf dem Gerät durchzuführen.**

5. Modellnummer

Diese Funktion zeigt die Modellnummer der Leuchte an und dient auch als ID-Name wenn die RSX über das Syna-G-System mit einem iOS- oder Android-Gerät verbunden wird. **Unter normalen Umständen sollte dieser Wert nicht geändert werden.**

6. Standard- oder Master / Slave-Modus

Diese Funktion ermöglicht es dem Benutzer, zwischen dem Standard-Betriebsmodus oder dem Master / Slave-Modus zu wählen, bei dem mehrere RSX-Einheiten miteinander verbunden werden.

Sobald sie angeschlossen sind, folgen alle Slave-Leuchten den Einstellungen die auf der Master-Leuchte programmiert werden, was Zeit und Mühe beim Einrichten mehrerer Leuchten spart.

Der Normalwert ist "Standard", d.h. das Gerät läuft im Standard-Betriebsmodus

Wenn eine RSX als Master Leuchte eingestellt ist, muss der Leuchte einen Kanal von 01 bis 10 zugewiesen werden. Alle Slave-Einheiten müssen dann ebenfalls dem gleichen Kanal zugeordnet werden.

Wenn es mehrere Gruppen von Master / Slave Leuchten gibt, muss jeder Gruppe einen anderen Kanal zugewiesen werden, um Interferenzen mit einer anderen Gruppe zu vermeiden.

- Drehen Sie das Einstellrad um "Standard" auszuwählen.
- Drücken Sie auf das Einstellrad, um das Einstellmenu aufzurufen.
- Drehen Sie das Einstellrad, um die Leuchte als "Master" oder "Slave" einzustellen.
- Nach Auswahl als Master / Slave-Einheit, drücken Sie die Taste um einen Kanal zuzuweisen.
- Den Drehregler 3 Sek. lang gedrückt halten, um die Einstellung zu speichern.

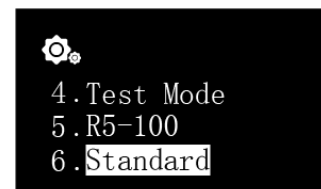

7. Verlassen

- Drücken Sie "Exit", um die Leuchte neu zu starten.

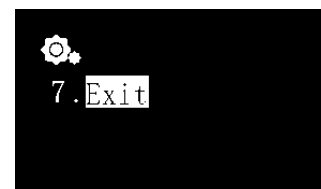

Wartung der Leuchte

Benutzer müssen eine regelmäßige Wartung der Leuchte durchführen, einschließlich, aber nicht beschränkt auf die folgenden Schritte:

- Mit einem feuchten Tuch die Optiken gut reinigen, um sicherzustellen, dass sie nicht von Salzkristen oder anderen Schmutz und Trümmern bedeckt sind. Ungereinigte Optiken wird die Lichtleistung der Leuchte sehr stark beeinträchtigen. Für eine optimale Leistung sollten die Optiken mindestens einmal pro Woche gereinigt werden.
- Reinigen Sie den Staub und den Schmutz in den Lüftern. Regelmäßig und richtig gereinigte Lüfter werden viel länger halten! Die Lüfter sind Verschleißteile und sollten alle 18-24 Monate ausgetauscht werden. Die Lebensdauer der Lüfter hängt von der Häufigkeit der Wartung ab.
- Reinigen / entfernen Sie jegliche Salzkristen, Dreck oder Schmutz, die sich auf dem Aluminiumkörper der Leuchte aufgebaut oder gesammelt haben, da sie die Ableitung von Wärme von der Vorrichtung beeinflussen können.

Hinweis: Die Nichtbeachtung der oben genannten Wartungsarbeiten an der Leuchte kann zu unnötigen Schäden an Ihrem Gerät führen und Ihre Garantie erlöschen!

Hinweis:

Für neusten technischen Daten, LED-Layout, LED-Typen und Farbspektrum besuchen Sie bitte unsere Internetseite unter www.maxspect.com.



Maxspect Ltd. haftet für alle Produkte des Maxspect™ RSX LED- Beleuchtungssystems gegen Mängel in der Ausführung für einen Zeitraum von 12 Monaten ab dem Kaufdatum. Wenn ein Mangel während der Garantiezeit vorliegt, wird Maxspect Ltd das Produkt kostenlos nach eigenem Ermessen entweder reparieren (mit neu- oder Austauschteilen) oder das Produkt ersetzen (durch ein neues oder ein Austauschgerät).

DIE GARANTIE GILT NICHT FÜR PRODUKTE, DIE DURCH FALSCHER ANWENDUNG, VERÄNDERUNGEN, UNFÄLLE, UNSACHGEMÄSSE HANDHABUNG ODER EINGRIFFE BESCHÄDIGT WURDEN ODER AN DENEN REPARATUREN ODER REPARATURVERSUCHE VON NICHT-AUTORISIERTEN PERSONEN VORGENOMMEN WURDEN. ZU MÖGLICHEN SCHÄDEN, DIE NICHT VON DER GARANTIE ABGEDECKT SIND, GEHÖREN UNTER ANDEREM (ABER NICHT AUSSCHLIESSLICH) DER EINSATZ VON NACHGEMACHTEN LED-LEUCHTEN UND VERÄNDERUNGEN AN DEN SCHALTKREISEN, DIE VERMUTLICH SCHÄDEN AUFGRUND VON FALSCHER ANWENDUNG ODER MISSBRAUCH SIND.

HAFTUNGSAUSSCHLUSS FÜR FOLGE- UND ZUFALLSSCHÄDEN:

Sie und alle anderen Nutzer der Produkte von Maxspect Ltd. haben kein Recht auf Entschädigung bei Folge – und Zufallsschäden, einschließlich und ohne Einschränkung bei Verlust des Geräts, Unannehmlichkeiten, Schäden am Privateigentum, Telefonanrufe, entgangenes Einkommen und entgangene Umsätze. Diese Garantie gesteht Ihnen bestimmte Rechte zu und Sie können zudem weitere Rechte haben, die von Land zu Land unterschiedlich sein können.

MAXSPECT LTD. GIBT KEINE GARANTIE UND ÜBERNIMMT KEINE VERANTWORTUNG FÜR DAS PRODUKT, WEDER AUSDRÜCKLICH NOCH IMPLIZIT, IN BEZUG AUF DIE QUALITÄT, LEISTUNG, MARKTGÄNGIGKEIT ODER EIGNUNG FÜR EINEN BESTIMMTEN ZWECK. DAHER WIRD DAS PRODUKT IN DER VORLIEGENDEN FORM („AS IS“) VERKAUFT UND SIE ALS KÄUFER TRAGEN DAS GESAMTE RISIKO IN BEZUG AUF QUALITÄT UND LEISTUNG.

MAXSPECT LTD IST IN KEINEM FALL HAFTBAR FÜR DIREKTE, INDIREKTE, ZUFÄLLIGE SCHÄDEN BZW. FOLGESCHÄDEN, DIE AUS EINEM FEHLER DES PRODUKTS ODER SEINER BEDIENUNGSANLEITUNG ENTSTEHEN KÖNNTEN.

Die oben dargelegte Garantie, Haftungsausschlüsse und Rechtsbehelfe sind exklusiv und ersetzen alle anderen mündlichen oder schriftlichen, ausdrücklichen oder impliziten Absprachen. Zu keinem Zeitpunkt sind die Maxspect Ltd. Händler, Agenten oder Mitarbeiter berechtigt, irgendwelche Änderungen, Erweiterungen oder Zusätze an dieser Garantie vorzunehmen.

Einige Länder erlauben den Ausschluss oder die Beschränkung von implizierten Garantien oder Haftungen für Zufalls- oder Folgeschäden nicht, so dass die oben genannten Beschränkungen oder Ausschlüsse eventuell nicht auf Sie zutreffen.

Preset 1

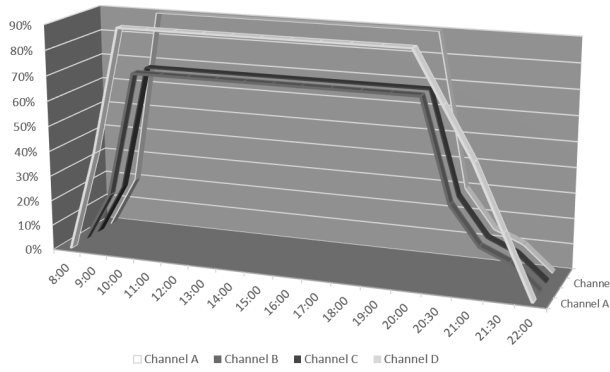

Preset 2

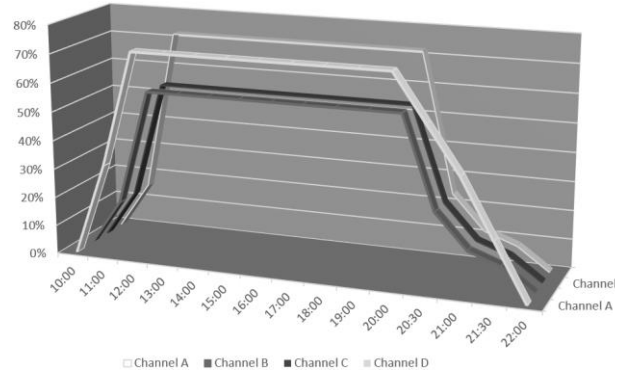

Preset 3

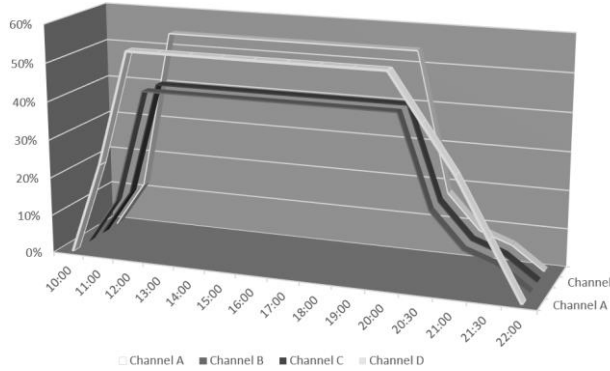

Preset 4

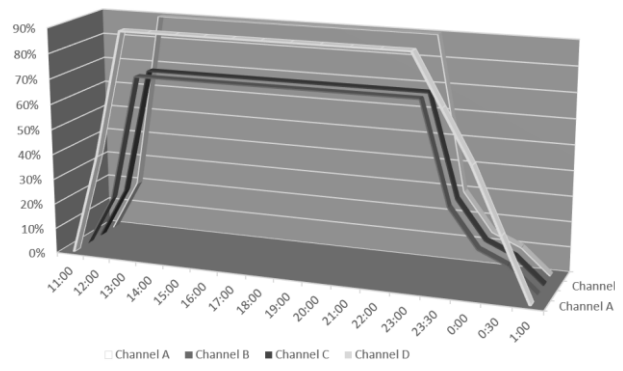

Deutsch

Cher Client,

Merci d'avoir acheté ce produit.

Pour des performances et une sécurité optimales, veuillez lire attentivement ces instructions.

Mémo utilisateur:

Date d'achat :

Nom du revendeur :

Adresse du revendeur :

Site internet du revendeur :

E-mail du revendeur :

N° de téléphone du revendeur :

Français

Vous pouvez nous rejoindre sur facebook ou twitter !



<https://www.facebook.com/Maxspect>



<http://twitter.com/maxspectled>

Contenu de l'emballage

Merci de vérifier le contenu de votre emballage.

R5-100

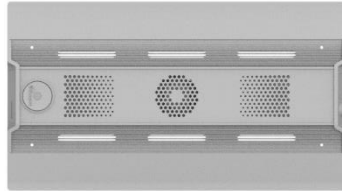

R5-150

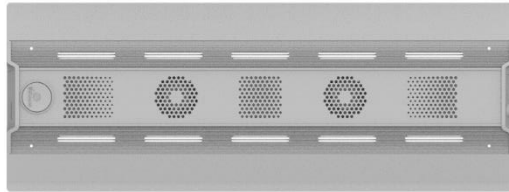

R5-200

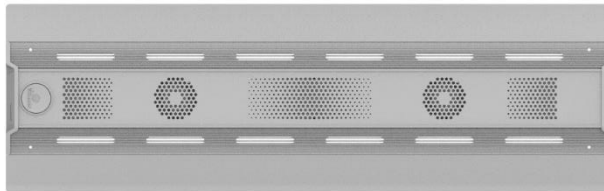

R5-300

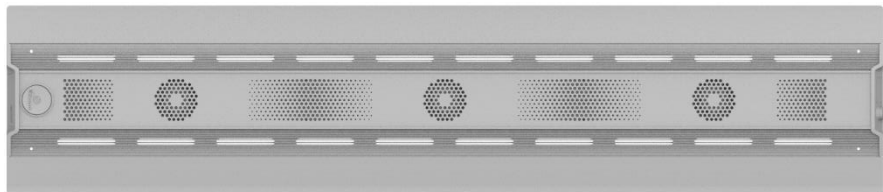

Alimentation

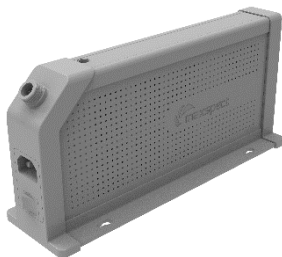

câble d'alimentation



PVC Autocollant

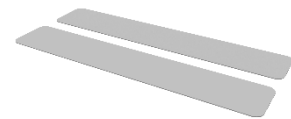

Support pour aquarium



Vis manuelles

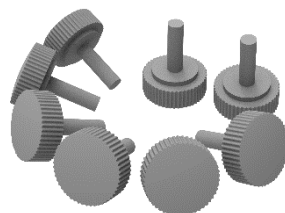

vis

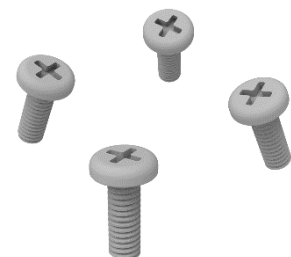

Précautions d'utilisation

Avant toute utilisation du système d'éclairage LED RSX Maxspect™, veuillez lire attentivement ce manuel d'utilisation. Soyez particulièrement attentifs aux consignes de sécurité qui suivent.

Gardez soigneusement ce manuel pour toute future utilisation.

Avant d'utiliser le système d'éclairage LED RSX Maxspect™

1. Si présent, retirez le film protecteur des lampes LED avant toute utilisation.
2. Ne regardez jamais directement dans la lumière quand vous mettez le système en marche. Une utilisation inappropriée de cet appareil augmente les risques de lésions oculaires.

Français

Sécurité

1. **Alimentation électrique** – Ne dégradez pas le système de sécurité de la prise électrique à deux broches. La prise sécurisée possède deux broches rondes et une fiche ronde reliée à la terre. La fiche ronde assure votre sécurité. Si le connecteur électrique du système ne correspond pas à la prise murale, contacter un électricien pour le remplacement de la prise obsolète.
2. **Protection du cordon d'alimentation** – Le cordon doit être installé de sorte qu'il ne puisse pas être piétiné ou coincé par des objets placés sur ou contre lui. Ne tenez jamais la prise ou le cordon si vos mains sont humides et saisissez toujours le corps de la prise lors de la connexion ou déconnexion du cordon d'alimentation.
3. **Installation** – Le système doit être installé en intérieur uniquement et utilisé avec les fixations, cadre de montage, kit de suspension et accessoires fournis par le fabricant.

Utilisation

1. **Utilisation** – Suivez toujours les instructions d'utilisation décrites dans ce manuel lorsque vous utilisez le système d'éclairage LED RSX.
2. **Chaleur** – L'appareil doit être éloigné de toute source de chaleur comme des radiateurs et ne doit pas être exposé à des sources de chaleur importante comme le feu ou les rayons de soleil.
3. **Humidité** – Afin de réduire tout risque de choc électrique, maintenez cet appareil à l'abri de la pluie et de toute source d'humidité.
4. **Ventilation** – L'appareil doit être disposé de façon à ce que son emplacement et sa position n'interfèrent pas avec sa propre ventilation.
5. **Magnétisme** – L'appareil doit être disposé à l'écart de tout équipement ou dispositif qui génère un champ magnétique important.
6. **Nettoyage** – Nettoyez uniquement à l'aide d'un chiffon sec.

Fixation du Système d'Eclairage LED RSX

Avant de connecter le module LED à l'alimentation, assemblez tout d'abord le système en utilisant le support fourni.

1. Support pour pose sur aquarium

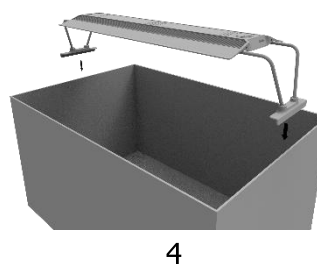
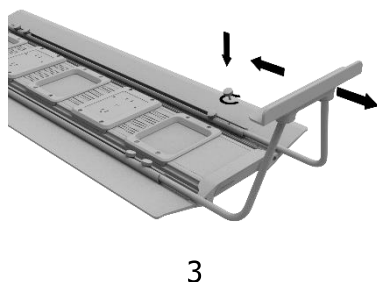
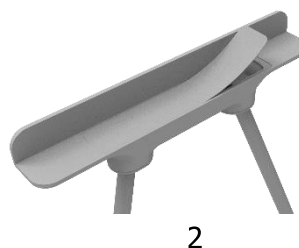
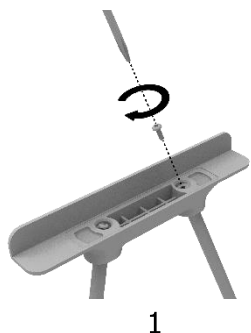

2. Fixation plafond (kit de suspension en option)

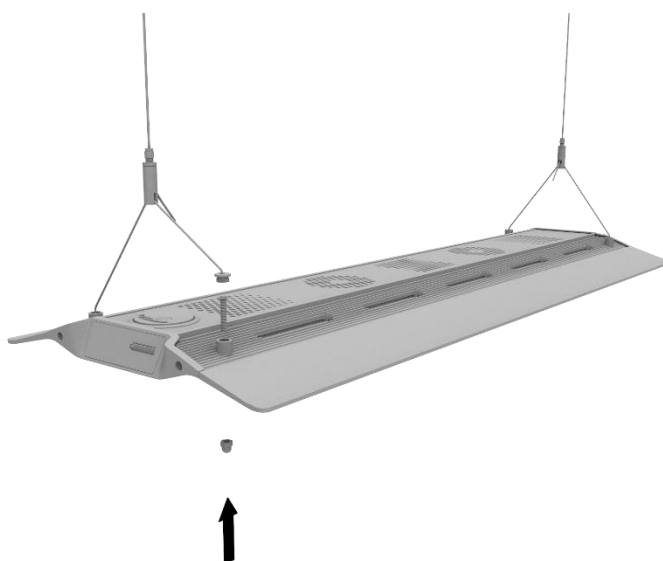

Instructions d'utilisation

Contrôleur intégré

La RSX peut être contrôlée directement grâce au contrôleur intégré. Celui-ci dispose d'un afficheur OLED et d'une molette de réglage à partir desquels l'utilisateur peut configurer toutes les fonctions de la RSX.



Français

Mode standard ou maître / esclave

A partir de 2 unités ou plus, l'utilisateur peut connecter les RSXs en mode maître/esclave pour un contrôle simultané. Toutes les RSXs en mode esclave adopteront les réglages qui seront effectués sur la RSX maître, ce qui dispensera l'utilisateur d'effectuer la programmation de chaque RSX et lui fera économiser du temps.

Contrôle avec appareils iOS ou Android (en option)

La RSX peut également être connectée sans fil à un contrôleur ICV6 (vendu séparément), ce qui permet de la contrôler avec des appareils iOS ou Android via le système Syna-G.



Opérations de base

Suivez les instructions suivantes pour utiliser et la programmer le module LED RSX.

Le module LED s'allume automatiquement lorsque l'alimentation est connectée, et s'éteint lorsque l'alimentation est coupée.

Lorsque l'alimentation est rétablie, le module Led revient automatiquement à la sauvegarde précédente, il garde également le niveau d'intensité sélectionné pour tous les canaux LED.

Le ventilateur de la RSX est contrôlé par la température.

La RSX dispose d'un système intégré de contrôle de la température. Le ventilateur est automatiquement activé lorsque la température est supérieure à 55° C et désactivé lorsqu'elle est inférieure à 45° C.

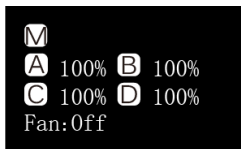

Inférieure 45°C/113°F

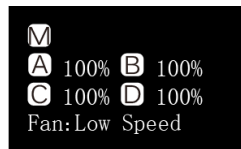

Supérieure 55°C/131°F

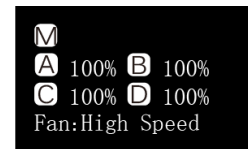

Supérieure 65°C/149°F

Si le ventilateur venait à être défectueux, la lampe pourrait surchauffer. Mais grâce à son système de protection, la RSX est automatiquement désactivée lorsque la température est supérieure à 80°C. Lorsque la température passe sous 70°C la RSX se rallumera automatiquement et continuera à fonctionner normalement.

Commutation entre mode Auto et Manuel.

La RSX dispose de 2 modes de fonctionnement: le mode automatique et manuel. L'utilisateur peut choisir entre les 2 modes avec la molette de commande.



- Appuyer et maintenir la touche de commande pendant 3 secondes pour passer d'un mode à l'autre.

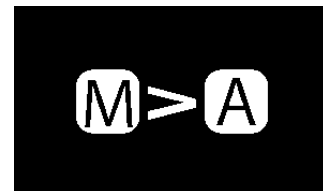

Instructions d'utilisation

Mode manuel

- Appuyer sur la molette de commande pour entrer dans le menu de réglage.
- Appuyer à nouveau sur la molette de commande pour choisir entre les canaux.
- Tourner la molette de commande pour régler la luminosité de chaque canal LED.
- Appuyer et maintenir la touche de commande pendant 3 secondes pour sauvegarder le réglage et quitter le menu de réglage.

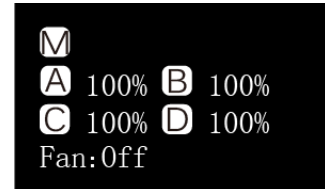

Mode automatique

- Appuyer sur la molette de commande pour entrer dans le menu de réglage.
- Tourner la molette de commande pour basculer entre les réglages.
- Appuyer et maintenir la touche de commande pendant 3 secondes pour sauvegarder le réglage et quitter le menu de réglage.

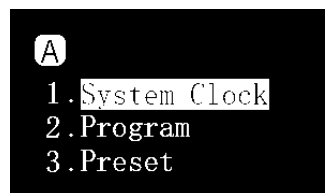
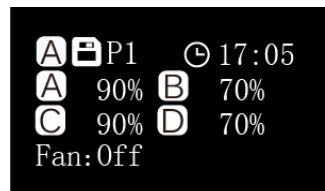

En mode automatique, il y a 3 paramètres de sélection pour l'utilisateur:

System Clock: réglage de l'horloge afin de correspondre à l'heure locale de l'utilisateur.

Program: programmation de la photopériode pour définir la luminosité spécifique de chaque canal LED pour les différentes heures de la journée.

Preset: 4 réglages prédéfinis sont disponibles et peuvent être choisis par l'utilisateur.

(Reportez-vous à la page 48).

P1: aquarium à dominante SPS.

P2: aquarium mixte SPS / LPS.

P3: aquarium mixte coraux mous / LPS.

P4: aquarium à dominante SPS avec une heure d'aurore et de crépuscule différente et avec le mode lunaire.

Réglage de l'horloge

- Appuyer sur la molette de commande pour entrer dans le menu de réglage, puis sélectionner "System Clock".
- Appuyer sur la molette de commande pour basculer entre les heures et les minutes.
- Tourner la molette pour régler l'heure.
- Appuyer et maintenir la touche de commande pendant 3 secondes pour sauvegarder le réglage et quitter le menu de réglage.

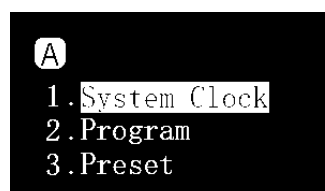

Instructions d'utilisation

Comprendre les points de temps

Il y a un total de 24 points temps. Vous pouvez programmer différentes intensités lumineuses pour chaque point temps afin d'ajuster la photopériode et la luminosité du système.

Sélectionner Preset P1 par exemple: ce sont des paramètres pour un aquarium à dominante SPS. La photopériode débute à 8 h 00 puis l'intensité lumineuse augmente progressivement jusqu'à un pic à 10 h 00 qui se prolonge jusqu'à 20 h 00, puis l'intensité lumineuse diminue graduellement jusqu'à l'extinction à 22 h 00 avec le mode lunaire en marche.

Français

	TP01	TP02	TP03	TP04	TP05	TP06	TP07	TP08
	08:00	09:00	10:00	20:00	20:30	21:00	21:30	22:00
Canal A	0%	40%	90%	90%	70%	50%	25%	0%
Canal B	0%	20%	70%	70%	30%	15%	10%	0%
Canal C	1%	20%	70%	70%	30%	15%	10%	1%
Canal D	0%	20%	90%	90%	30%	15%	10%	0%

Le diagramme suivant illustre comment les 4 canaux LED fonctionnent une fois les points-temps ci-dessus programmés.

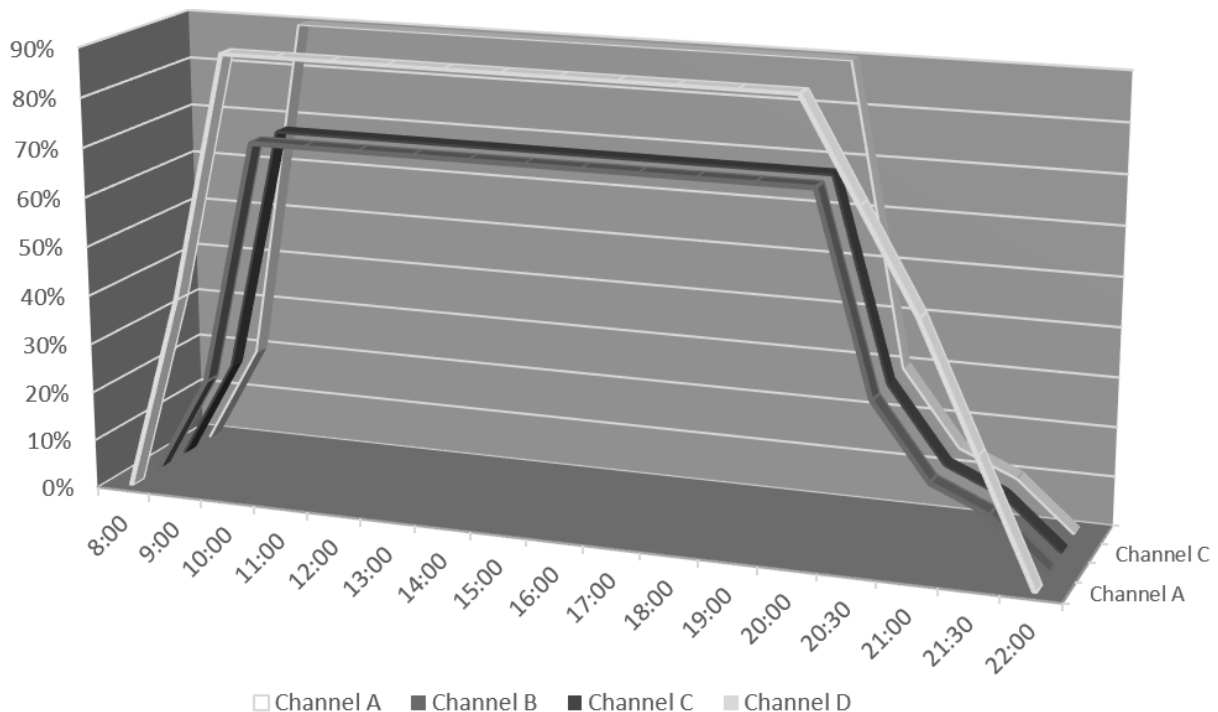

Instructions d'utilisation

Programmation de la photopériode

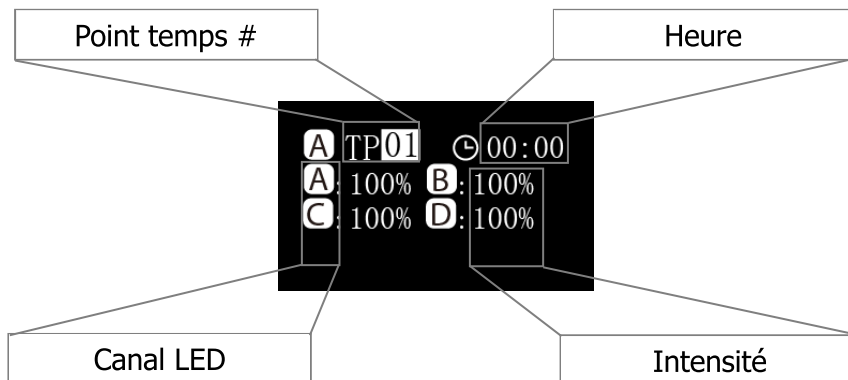

Français

Modifier

- Appuyer sur la molette de commande pour basculer entre les paramètres.
- Tourner la molette de commande pour régler les paramètres.
- Appuyer et maintenir la molette de commande pendant 3 secondes pour passer au menu suivant.

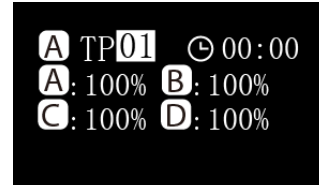

Confirmer

- Tourner la molette de commande pour sélectionner "Apply".
- Appuyer sur la molette de commande pour enregistrer le réglage.
- Appuyer et maintenir la molette de commande pendant 3 secondes pour revenir au menu principal.



Aperçu

- Tourner la molette de commande pour sélectionner "Preview".
- Appuyer sur la molette de commande pour prévisualiser le programme de toute la photopériode en 3 minutes.
- Appuyer et maintenir la molette de commande pendant 3 secondes pour revenir au menu principal.



- Tourner la molette de commande pour sélectionner "Modify".
- Appuyer pour modifier le réglage des paramètres, voir "Modifier" ci-dessus.



Sélection du préréglage

- Tourner la molette de commande pour basculer entre les préréglages.
- Appuyer sur la molette de commande pour passer au menu suivant.

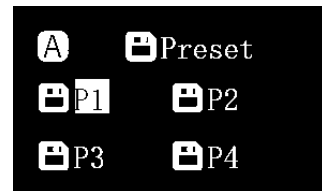

Confirmer

- Tourner la molette de commande pour sélectionner "Apply".
- Appuyer sur la molette de commande pour enregistrer le réglage.



Aperçu

- Tourner la molette de commande pour sélectionner "Preview".
- Appuyer sur la molette de commande pour prévisualiser le programme de toute la photopériode en 3 minutes.
- Appuyer et maintenir la molette de commande pendant 3 secondes pour revenir au menu principal.

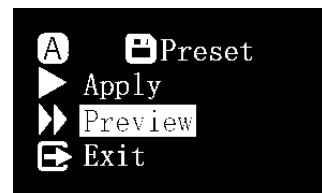

Quitter

- Tourner la molette de commande pour sélectionner "Exit".
- Appuyer sur la molette de commande pour revenir au menu principal.



Instructions de maintenance

Configuration du système

La configuration du système comporte un ensemble de fonctions permettant à l'utilisateur de réaliser une maintenance sur la rampe.

Pour accéder au menu de configuration du système, éteindre d'abord l'appareil, puis appuyer et maintenir la molette de commande tout en allumant l'appareil. Maintenir la molette de commande jusqu'à ce que le menu de configuration du système soit affiché sur le moniteur OLED.

7 fonctions s'affichent sur l'écran de configuration du système.

1. Firmware
2. Restaurer
3. Réinitialiser
4. Mode test
5. Numéro du modèle
6. Mode standard ou maître / esclave
7. Quitter

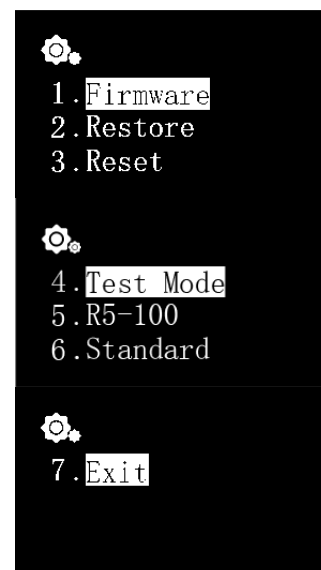

Français

1. Firmware

Cette fonction permet à l'utilisateur de mettre à jour le firmware.

- Tourner la molette de commande pour sélectionner "Firmware".
- Appuyer sur la molette de commande pour faire la mise à jour du firmware.
- S'il n'y a pas de carte TF(micro SD) ou si le firmware sur la carte TF est incorrect, „NO TF-Karte" ou „Wrong File" seront affichés.
- Dans le cas contraire, la progression de la mise à jour du firmware sera affichée.
- Une fois le firmware mis à jour, la rampe redémarre automatiquement et la nouvelle version du firmware sera affichée.

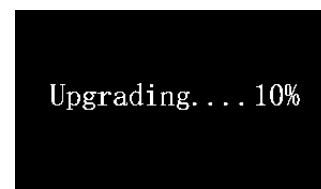

Instructions de maintenance

2. Restaurer

Cette fonction permet à l'utilisateur de restaurer le firmware au réglage d'usine. Après avoir terminé la restauration du firmware, la rampe redémarre automatiquement et la version du firmware sera affichée.

- Tourner la molette de commande pour sélectionner "Restore".
- Appuyer sur la molette de commande pour restaurer le firmware.



Français

3. Réinitialiser

Cette fonction permet à l'utilisateur de réinitialiser la rampe en réglage d'usine. Après réinitialisation, la rampe redémarre automatiquement.

- Tourner la molette de commande et sélectionner "Reset".
- Appuyer sur la molette de commande pour réinitialiser la rampe.



4. Mode test

Cette fonction permet à l'utilisateur de mettre la rampe en mode test afin d'aider notre service après-vente à faire un diagnostic de celle-ci. **Cette fonction ne doit être utilisée que lorsqu'un revendeur agréé le demande pour effectuer certains tests sur la rampe.**

5. Numéro du modèle

Cette fonction affiche le numéro de modèle de l'appareil, qui sert également de nom ID lorsque la RSX est connectée à un périphérique iOS ou Android via le système Syna-G. **Normalement cette valeur ne doit pas être modifiée.**

Instructions de maintenance

6. Mode standard ou maître / esclave

Cette fonction permet à l'utilisateur de choisir entre le mode de fonctionnement standard ou le mode maître /esclave quand plusieurs unités RSXs sont connectées ensemble.

Une fois connectées, toutes les rampes esclaves suivront les réglages programmés sur la RSX maître. Cela permet d'économiser du temps lors de la configuration de plusieurs rampes.

La valeur par défaut est "Standard", ce qui signifie que la lampe est en mode de fonctionnement seule.

Lorsque la RSX est définie comme unité maître, il faudra lui attribuer un canal entre 01 et 10. Toutes les RSXs connectées en esclaves devront également être affectées au même canal.

Si plusieurs groupes maître / esclave doivent coexister, il faut attribuer à chaque groupe un canal différent afin d'éviter toute interférence avec l'autre groupe.

- Tourner la molette de commande pour sélectionner "Standard".
- Appuyer sur la molette de commande pour accéder au menu de réglage.
- Tourner la molette de commande pour choisir entre "Maître" ou "Esclave".
- Après avoir sélectionné maître / esclave, appuyer sur la molette de commande pour attribuer un canal.
- Appuyer et maintenir la molette de commande pendant 3 secondes pour sauvegarder le réglage.

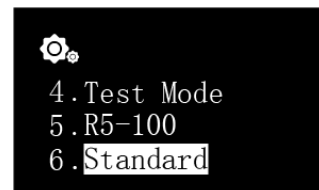

7. Quitter

- Appuyer sur "Exit" pour redémarrer la rampe.

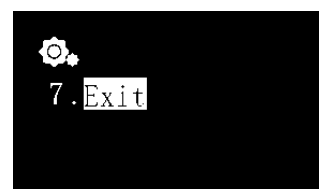

Entretien de votre rampe

Pour garantir un bon fonctionnement de votre rampe, un entretien périodique de votre rampe doit être effectué:

- À l'aide d'un chiffon humide, nettoyer les pads optiques afin d'enlever toutes salissures, traces de sel ou autres souillures. Des pads optiques non nettoyées affecteront gravement la performance lumineuse de la rampe. Aussi un nettoyage hebdomadaire des optiques est fortement recommandé.
- Chaque semaine, contrôlez les ventilateurs et enlevez la poussière et les déchets qui peuvent gêner leur bon fonctionnement. Les ventilateurs sont des pièces d'usure et ils doivent être remplacés tous les 18 à 24 mois, selon la fréquence de l'entretien. Des ventilateurs régulièrement et correctement entretenus durent plus longtemps.
- Nettoyez / enlevez régulièrement les saletés, souillures et traces de sel qui se déposent sur le bâti en aluminium de la lampe car ils peuvent affecter la bonne dissipation de la chaleur.

Remarque: Le non-respect des consignes d'entretien mentionnées ci-dessus peut causer des dommages inutiles à votre appareil et peut annuler votre garantie!

Remarque:

Pour les dernières spécifications sur la disposition, du type et du spectre de couleurs des LED, veuillez-vous rendre sur notre site Web à www.maxspect.com.



Limite de garantie

Maxspect Ltd. garantit tous les produits du système d'éclairage LED RSX Maxspect™ contre les défauts de fabrication ou de matériaux pendant une période de 12 mois à compter de la date d'achat. Si un défaut est révélé au cours de la période de garantie, Maxspect Ltd., à sa convenance, réparera (avec des pièces neuves ou de rechanges) ou remplacera (par une unité nouvelle ou réparée) le produit, gratuitement.

LA GARANTIE NE S'APPLIQUE PAS AU PRODUIT S'IL A ÉTÉ ENDOMMAGÉ PAR UNE MAUVAISE UTILISATION SUITE À UNE MAUVAISE MANIPULATION, UNE INSTALLATION INCORRECTE, AU TRANSPORT OU POUR DES TENTATIVES DE RÉPARATION PAR DES PERSONNES NON AUTORISÉES. DES EXEMPLES DE DOMMAGES NON COUVERTS PAR LA GARANTIE INCLUENT, MAIS NE SE LIMITENT PAS A L'UTILISATION DE LED DE REMPLACEMENT ET MODIFICATION DES CIRCUITS DONT POURRAIENT RESULTER DES DOMMAGES DUS A UNE MAUVAISE UTILISATION OU UN MAUVAIS TRAITEMENT.

Français

EXCLUSION DE DOMMAGES IMMATERIELS OU ACCESSOIRES :

Maxspect Ltd. ne peut en aucun cas être tenu pour responsable des dommages directs, indirects ou conséquents comprenant mais non limités à : la perte de l'usage de l'unité, désagréments, dégâts matériels à des biens personnels, appels téléphoniques, perte de revenus ou de salaire. Cette garantie vous donne des droits légaux spécifiques ainsi que d'autres droits éventuels, qui peuvent varier d'un pays à l'autre.

MAXSPECT LTD. N'OFFRE AUCUNE GARANTIE, QU'ELLE SOIT EXPRESSE OU IMPLICITE, QUANT A LA QUALITE DES PRODUITS, LES PERFORMANCES, SA COMMERCIALISATION OU L'ADAPTATION A UN USAGE DIFFERENT DE CELUI AUQUEL IL EST DESTINE. EN CONSEQUENCE, CES PRODUIT SONT VENDUS «TELS QUELS», ET VOUS, ACHETEUR, ASSUMEZ ENTIEREMENT LES RISQUES QUANT A SA QUALITE ET SES PERFORMANCES.

EN AUCUN CAS MAXSPECT LTD NE SERA RESPONSABLE DE DOMMAGES DIRECTS, INDIRECTS, PARTICULIERS, ACCESSOIRES OU CONSECUTIFS RESULTANTS DE TOUT DEFAUT DU PRODUIT OU DE SA DOCUMENTATION.

LA GARANTIE, L'EXCLUSION ET LES MESURES PREVUES PRECEDEMMENT SONT EXCLUSIVES, ET REMPLACENT TOUTES LES AUTRES, ORALES OU ECRITES, EXPLICITES OU IMPLICITES. En aucun cas, des revendeurs, agents ou employés de Maxspect Ltd. ne seront autorisés à apporter des modifications, extensions ou ajouts à cette garantie.

Certains pays ne permettent pas l'exclusion ou la limitation des garanties implicites ou la responsabilité pour les dommages directs ou indirects, de sorte que la limitation ou l'exclusion de cette garantie peut ne pas vous être appliqué.

Preset 1

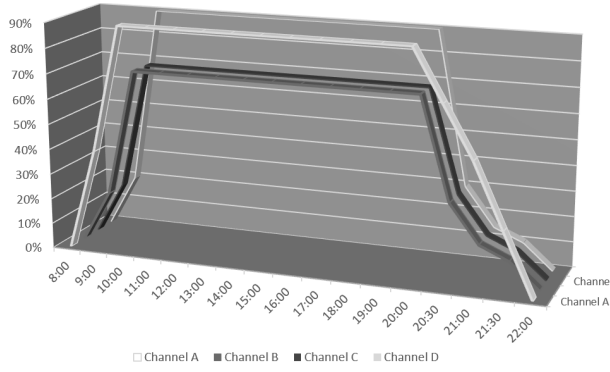

Preset 2

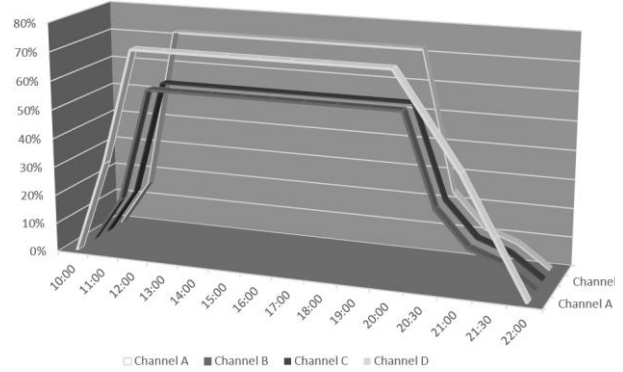

Preset 3

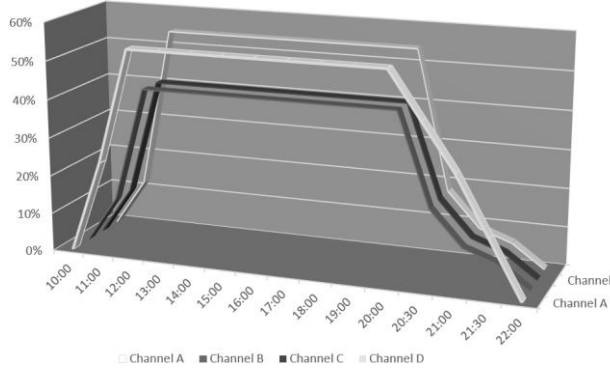

Preset 4

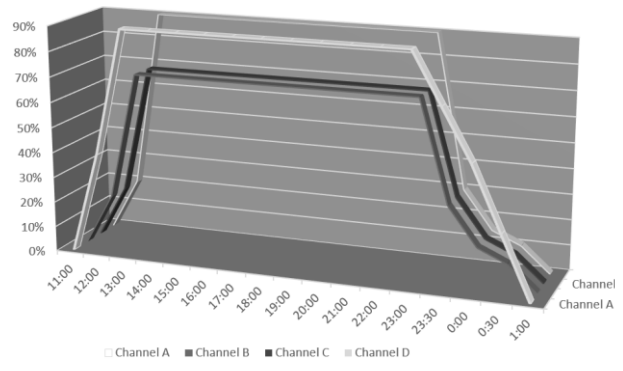

Français

Gentile Cliente,

Grazie e complimenti per aver acquistato il nostro prodotto .

Per ottimizzare prestazioni e sicurezza, vi preghiamo di leggere attentamente le istruzioni

Utente memo:

Data di acquisto: _____

Rivenditore: _____

Indirizzo del rivenditore: _____

Sito web del rivenditore: _____

E-mail del rivenditore: _____

Telefono del rivenditore: _____

Italiano

Puoi seguirci su facebook e twitter!



<https://www.facebook.com/Maxspect>



<http://twitter.com/maxspectled>

Per favore verifica il contenuto della scatola:

R5-100

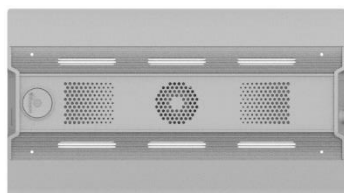

R5-150

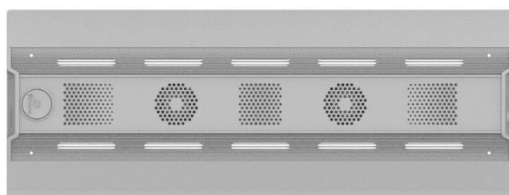

R5-200

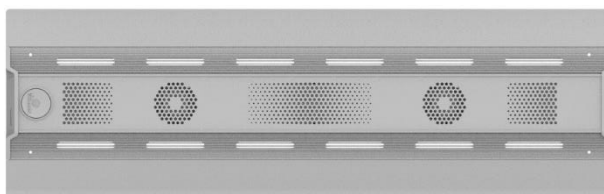

R5-300



Alimentation

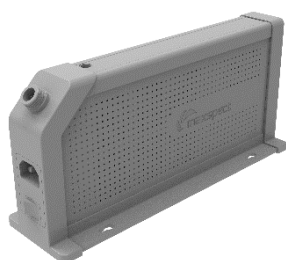

câble d'alimentation



PVC Sticker



Support pour aquarium



Vis manuelles

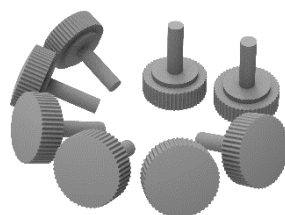

vis

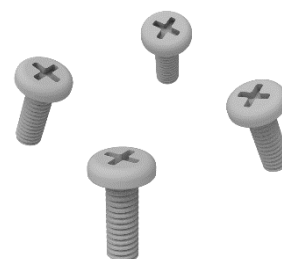

Prima di utilizzare il sistema d'illuminazione a LED Maxspect™ RSX hiano di leggere attentamente le istruzioni. Far particolare attenzione e seguire i suggerimenti di sicurezza elencati di seguito.

Successivamente tenere questo manuale a portata di mano per riferimento futuri

Prima di utilizzare il sistema d'illuminazione a LED Maxspect™

1. Rimuovere eventuali sacchetti di plastica e materiale d'imballaggio che proteggono l'apparecchio.
2. Non guardare mai direttamente i LED accesi. L'uso improprio di questo apparecchio aumenta i pericoli per gli occhi.

Sicurezza

1. **Alimentazione** – non annullare sulla spina la messa a terra. Se la spina non si inserisce nella presa, consultare un elettricista per la sostituzione della presa con una adatta.
2. **I cavi di alimentazione** – I cavi di alimentazione devono essere disposti in modo che non possano essere calpestati o schiacciati da oggetti posti sopra o contro di essi. Mai prendere in mano la spina o il cavo se la vostra mano è bagnata; afferrare sempre il corpo della spina per collegare o scollegare la stessa.
3. **Installazione** – Installare solo all'interno e mai all'esterno di locali; utilizzare gli accessori di montaggio previsti e specificati dal produttore.

Funzionamento

1. **Funzionamento** – Seguire sempre le istruzioni operative contenute nel presente manuale quando si utilizza questo sistema di illuminazione a LED RSX
2. **Calore** – L'apparecchio deve essere posto lontano da fonti di calore come termosifoni, non esporre a calore eccessivo come luce solare, fuoco o simili.
3. **Umidità** – Per ridurre il rischio di incendi o scosse elettriche non esporre questo apparecchio alla pioggia, umidità, gocciolamenti o spruzzi d'acqua.
4. **Ventilazione** – L'apparecchio deve essere posto in modo che la sua collocazione o posizione non interferisca con l'adeguata ventilazione.
5. **Magnetismo** – L'apparecchio deve essere collocato lontano da apparecchiature o dispositivi che generano forte magnetismo.
6. **Pulizia** – Pulire frequentemente solo con un panno asciutto e avendo cura di scollegare dall'alimentazione elettrica.

Montaggio del sistema d'illuminazione a LED RSX

Prima di collegare i moduli LED all'alimentazione montare completamente il sistema utilizzando il supporto fornito.

1. Montaggio a bordo vasca

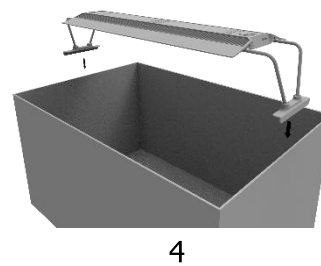
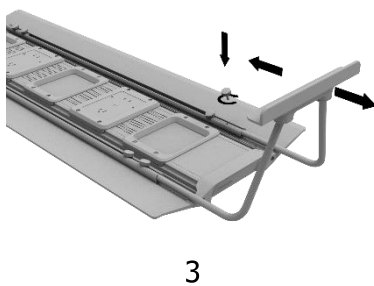
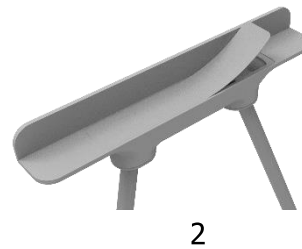
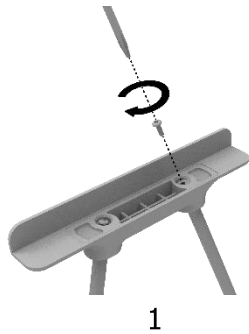

2. Montaggio in sospensione (kit di aggancio venduto separatamente)

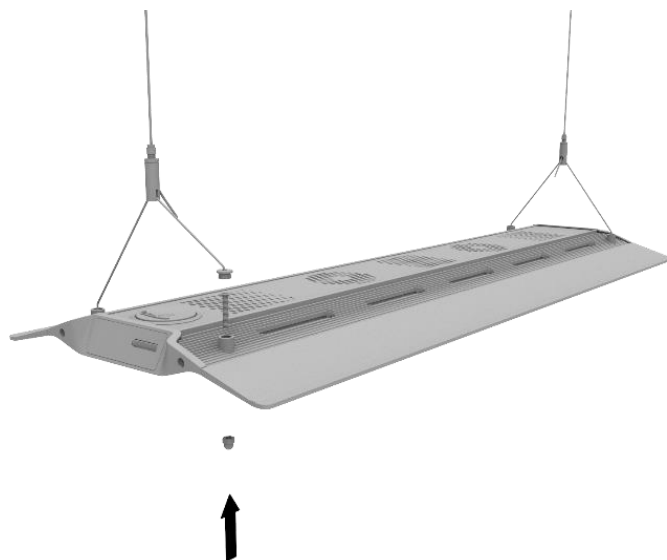

Istruzioni Per L'Uso

Controller incorporato

La RSX può essere controllata direttamente dal controller incorporato. Il controller integrato dispone di un display OLED e di una manopola di controllo che permettono all'utente di settare tutte le impostazioni della plafoniera.



Modalità Standard o Master/Slave

Quando abbiamo a che fare con 2 o più plafoniere RSX, l'utente può connetterle tra di loro attraverso la modalità Master/Slave che permette di controllarle simultaneamente. Tutte le unità aggiuntive, denominate Slave, seguiranno le impostazioni programmate sull'unità Master. Risparmiamo tempo e fatica necessari per impostare più plafoniere singolarmente.

Italiano

Controllo a mezzo dispositivi iOS o Android (opzionale)

The RSX can also be wirelessly connected to an ICV6 controller (sold separately), which allows the Recuve fixtures to be controlled by iOS or Android devices through the Syna-G System.



Operazioni di base

Seguire le istruzioni riportate di seguito per accendere e programmare il modulo a LED RSX.

Il modulo a LED si accende automaticamente non appena alimentato.

Quando l'alimentazione viene a mancare e poi ripristinata, il modulo a LED riprende le impostazioni precedenti il black-out.

La ventola sulla RSX è controllata dalla temperatura.

La RSX ha il sistema di controllo della temperatura incorporato. La ventola viene attivata in automatico quando la temperatura oltrepassa i 55°C/131°F e si spegne quando la temperatura scende sotto i 45°C/113°F.

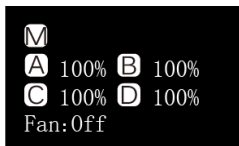

Sotto 45°C/113°F

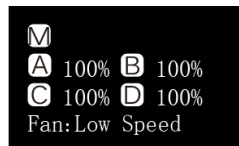

Oltrepassa 55°C/131°F

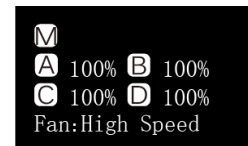

Oltrepassa 65°C/149°F

Se la ventola non si aziona la plafoniera può surriscaldarsi, in tal caso, superati i 80°C/176°F il sistema entrerà nella modalità fail-safe spegnendo tutti i canali. Il sistema uscirà dalla modalità fail-safe e riprenderà il regolare funzionamento quando la temperatura scenderà sotto i 70°C/158°F.

Passaggio tra modalità Automatica e Manuale

La RSX può operare in 2 modi: in modalità Automatica o Manuale. L'utente può passare da una modalità all'altra a mezzo manopola di controllo.



- Premi e tieni premuta la manopola di controllo per 3 secondi per passare da una modalità all'altra.

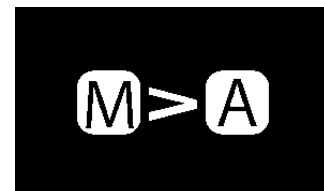

Istruzioni Per L'Uso

Modalità Manuale

- Premi la manopola di controllo per accedere alle impostazioni.
- Premi la manopola di controllo di nuovo per passare tra i canali.
- Ruota la manopola di controllo per impostare la luminosità su ciascun canale LED.
- Premi e tieni premuta la manopola di controllo per 3 secondi per salvare le impostazioni ed uscire.



Modalità Automatica

- Premi la manopola di controllo per accedere alle impostazioni.
- Ruota la manopola di controllo per passare tra le impostazioni.
- Premi e tieni premuta la manopola di controllo per 3 secondi per salvare le impostazioni ed uscire.

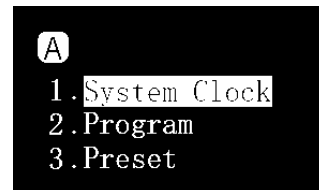
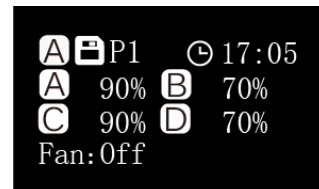

Nella modalità Automatica abbiamo 3 impostazioni da selezionare dall'utente:

System Clock: l'orologio deve essere impostato a seconda dell'ora locale.

Program: programmazione del fotoperiodo per impostare il grado di luminosità su ciascun canale in diversi intervalli di tempo nell'arco della giornata.

Preset: ci sono 4 impostazioni preimpostate a scelta tra: (Fare riferimento a pagina 64)

P1: vasca con prevalenza di SPS

P2: vasca mista con SPS/LPS

P3: vasca mista con coralli molli e LPS

P4: vasca con prevalenza di SPS, con il tempo alba/tramonto differente e con luce lunare.

Programmazione dell'orologio

- Premi la manopola di controllo per accedere alle impostazioni, di seguito seleziona "System Clock".
- Premi la manopola di controllo per passare tra ore a minuti.
- Ruota la manopola per settare il tempo.
- Premi e tieni premuta la manopola di controllo per 3 secondi per salvare le impostazioni ed uscire.

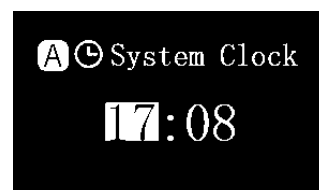
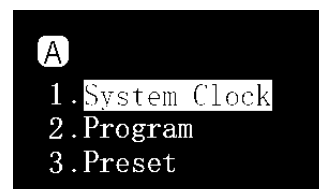

Significato dei Punti Tempo

Ci sono in totale 24 Punti Tempo. Puoi programmare un'intensità luminosa diversa su ogni Punto Tempo per controllare il fotoperiodo e la luminosità del sistema.

Prendi come esempio il Preset 1 che è settato per vasche con prevalenza di SPS. Il fotoperiodo inizia alle 8:00, il sistema aumenta la quantità di luce gradualmente, raggiungere il picco alle 10:00 e dura per 10 ore fino alle 20:00 quando il sistema inizia a diminuire la quantità di luce per spegnersi alle 22:00 con l'accensione della luce lunare.

	TP01	TP02	TP03	TP04	TP05	TP06	TP07	TP08
	08:00	09:00	10:00	20:00	20:30	21:00	21:30	22:00
Canale A	0%	40%	90%	90%	70%	50%	25%	0%
Canale B	0%	20%	70%	70%	30%	15%	10%	0%
Canale C	1%	20%	70%	70%	30%	15%	10%	1%
Canale D	0%	20%	90%	90%	30%	15%	10%	0%

Italiano

Il diagramma seguente evidenzia come si comporta il modulo a LED in base ai punti tempo programmati nell'esempio di sopra:

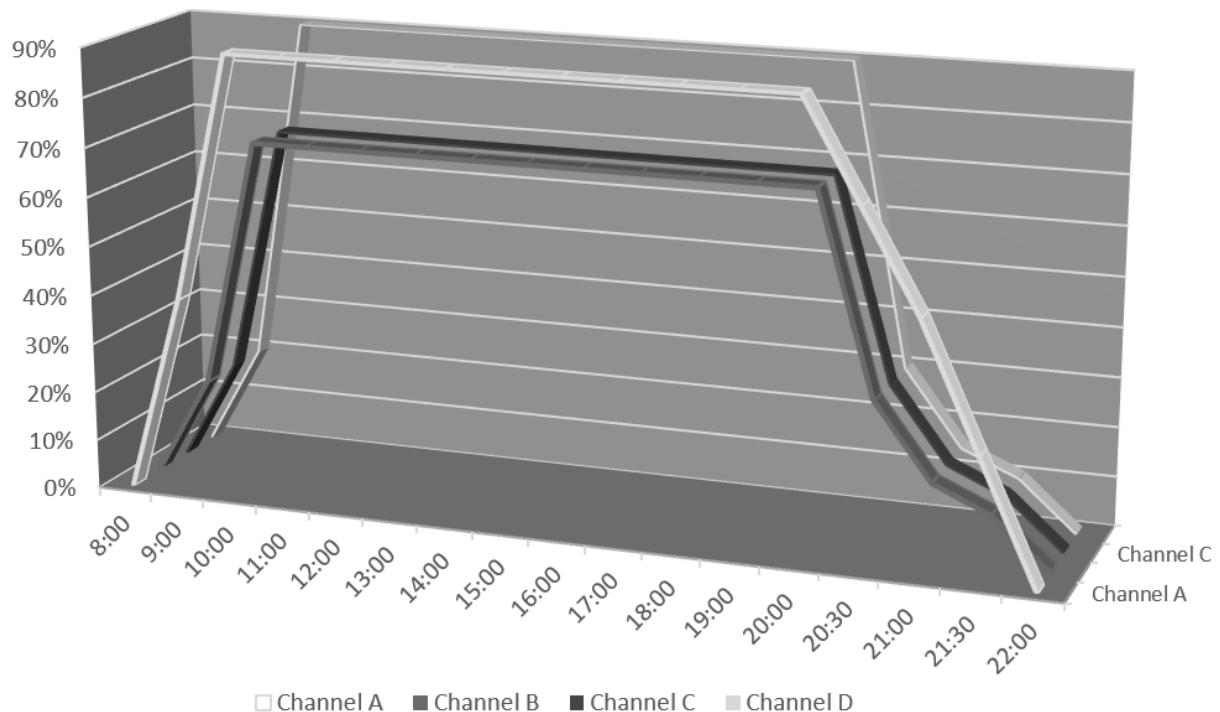

Programmazione del fotoperiodo

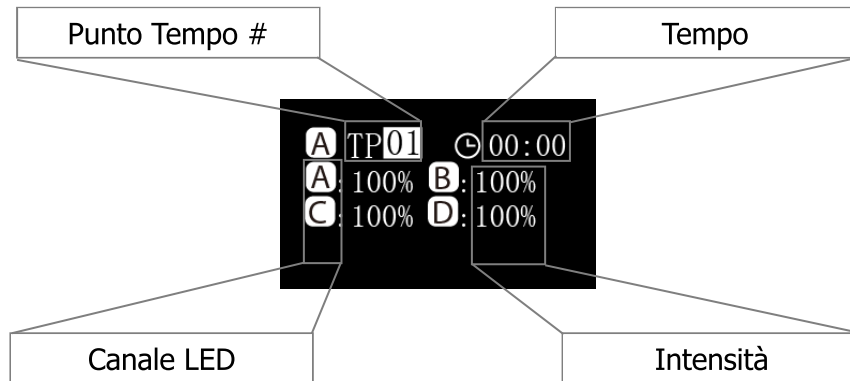

Modifica

- Premi la manopola di controllo per passare tra i parametri.
- Ruota la manopola di controllo per impostare i parametri.
- Premi e tieni premuta la manopola di controllo per 3 secondi per passare alla pagina successiva.

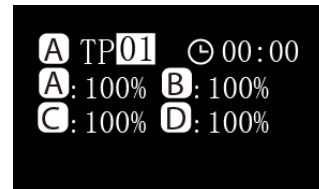

Italiano

Applica

- Ruota la manopola di controllo e seleziona "Apply".
- Premi la manopola di controllo per salvare le impostazioni.
- Premi e tieni premuta la manopola di controllo per 3 secondi per tornare al menù principale.



Anteprima

- Ruota la manopola di controllo e seleziona "Preview".
- Press the control dial to runs the program in preview mode, where the entire photoperiod is demonstrated in 3 minutes.
- Premi e tieni premuta la manopola di controllo per 3 secondi per tornare al menù principale.



- Ruota la manopola di controllo e seleziona "Modify".
- Premi per cambiare i parametri, vedi "Modify" qui sopra.



Selezione Preset

- Ruota la manopola di controllo per passare tra i Preset.
- Premi la manopola di controllo per passare alla pagina successiva.

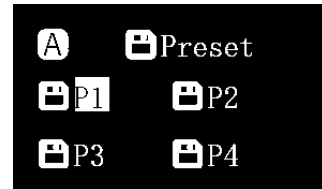

Applica

- Ruota la manopola di controllo e seleziona "Apply".
- Premi la manopola di controllo per salvare le impostazioni.



Anteprima

- Ruota la manopola di controllo e seleziona "Preview".
- Premi la manopola di controllo per azionare l'anteprima; l'intero fotoperiodo verrà mostrato per 3 minuti.
- Premi e tieni premuta la manopola di controllo per 3 secondi per tornare al menù principale.

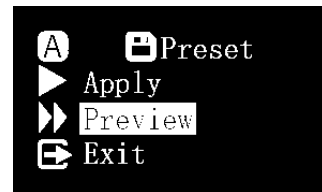

- Ruota la manopola di controllo e seleziona "Exit".
- Premi la manopola di controllo per tornare al Menù principale.



Configurazione del sistema

Nella configurazione del sistema è incluso un pacchetto di funzioni che permettono all'utente di eseguire le operazioni di manutenzione della plafoniera.

Per accedere alla pagina della configurazione del sistema per prima spegni la plafoniera di seguito premi e tieni premuta la manopola di controllo, riaccendi la plafoniera tenendo sempre la manopola premuta. Tieni la manopola premuta fino a quando sul monitor OLED appaia "System Setup".

Istruzioni di manutenzione

Sulla schermata "System Setup" appaiono 7 funzioni:

1. Firmware
2. Restore
3. Reset
4. Test Mode
5. Model Number
6. Standard or Master/Slave mode
7. Exit

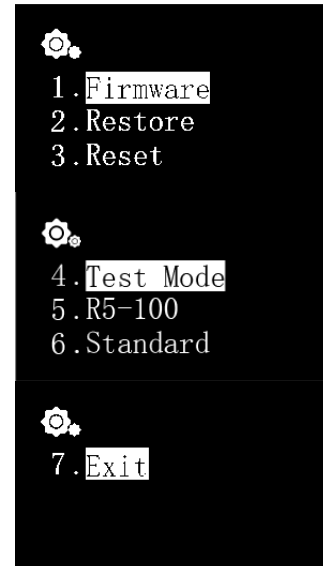

1. Firmware

Questa funzione permette all'utente di aggiornare il firmware.

- Ruota la manopola di controllo e seleziona "Firmware".
- Premi la manopola di controllo per avviare l'aggiornamento del firmware.
- In caso di assenza della scheda TF(micro SD), o quando il firmware sulla TF non è valido, appare la dicitura: "NO TF Card" o "Wrong File".
- In caso contrario verranno visualizzati gli aggiornamenti del firmware.
- Una volta aggiornato il firmware la plafoniera ripartirà automaticamente e verrà visualizzato il nr della nuova versione del firmware.



Upgrading... 10%



Italiano

Istruzioni di manutenzione

2. Restore

Questa funzione permette all'utente di ritornare alla versione del firmware originale (di fabbrica). Una volta completata l'operazione la plafoniera ripartirà automaticamente e verrà visualizzato il nr della versione del firmware.

- Ruota la manopola di controllo e seleziona "Restore".
- Premi la manopola di controllo per ristabilire il firmware.



3. Reset

Questa funzione permette all'utente di resettare la plafoniera e tornare alle impostazioni di fabbrica. A conclusione del reset la plafoniera ripartirà automaticamente.

- Ruota la manopola di controllo e seleziona "Reset".
- Press the control dial to factory reset the fixture.



4. Test Mode

Questa funzione permette all'utente di effettuare il test della plafoniera cui finalità è quella di aiutare il nostro servizio clienti a diagnosticare la stessa. **Questa operazione deve essere effettuata dall'utente solo a seguito della richiesta da parte del servizio clienti di effettuare determinati test sulla plafoniera.**

5. Model Number

Questa funzione visualizzerà il numero di modello della plafoniera necessario anche come ID nel caso in cui la RSX è connessa ad un dispositivo iOS o Android a mezzo sistema Syna-G. **In circostanze normali questo valore non deve essere modificato.**

Istruzioni di manutenzione

6. Standard or Master/Slave Mode

Questa funzione consente all'utente di scegliere tra la modalità di funzionamento autonomo Standard e la modalità Master/Slave ossia quando più unità di RSX devono essere connesse tra di loro.

Una volta stabilita la connessione, tutte le unità Slave seguiranno le stesse impostazioni programmate sull'unità Master il che permette di risparmiare tempo e fatica necessari per impostare più plafoniere.

Il valore predefinito è "Standard" il che significa che la plafoniera lavora in modalità autonoma.

Quando la RSX è impostata come unità Master occorrerà assegnarele un canale da 01 a 10. Tutte le unità Slave connesse devono essere assegnate allo stesso canale.

Nel caso in cui nelle vicinanze coesistano più gruppi Master/Slave, ad ogni unità Master deve essere assegnato un canale diverso per evitare l'interferenza con un altro gruppo.

- Ruota la manopola di controllo e seleziona "Standard".
- Premi la manopola di controllo per accedere alle impostazioni.
- Ruota la manopola di controllo per assegnare la plafoniera come unità "Master" o "Slave".
- Dopo aver selezionato l'unità Master / Slave premi la manopola di controllo per assegnare il canale.
- Premi e tieni premuta la manopola di controllo per 3 secondi per salvare le impostazioni.

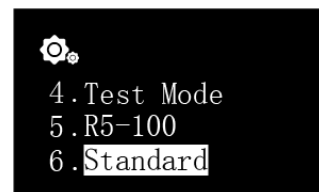

7. Exit

- Premi "Exit" per riavviare la plafoniera.

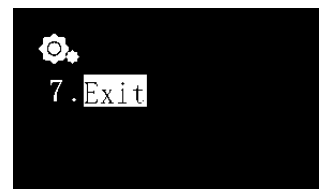

Informazioni importanti

Manutenzione della plafoniera

L'utente è tenuto ad eseguire periodicamente la manutenzione della plafoniera, compresi, ma non solo, i seguenti passaggi:

- Utilizzare un panno umido per pulire i riflettori in acrilico ed assicurarsi che non siano coperti da residui di sale o da altri elementi di sporco e detriti. La mancata pulizia dei riflettori influenzerà gravemente l'output luminoso della plafoniera, al fine di ottenere le migliori prestazioni occorre pulire i riflettori una volta alla settimana.
- Eliminare la polvere e detriti intrappolati nelle unità di ventilazione. Regolarmente e correttamente pulite, le ventole durano molto più a lungo rispetto a quelle che non lo sono. Le ventole sono parti soggette ad usura e devono essere sostituite ogni 24-36 mesi a seconda della frequenza di manutenzione eseguita su di esse.
- Pulire / rimuovere residui di sale e sporcizia che si sono accumulati sul corpo in alluminio della plafoniera in quanto potrebbero influenzare la dissipazione del calore dall'apparecchio.

Italiano

Nota: La mancata esecuzione della suddetta manutenzione sul dispositivo può provocare danni che si possono evitare alla vostra plafoniera ed il conseguente decadimento dei termini della garanzia!

Nota:

Per aggiornamenti relativi alla configurazione dei LED, tipi e colori dello spettro, siete pregati di consultare il nostro sito web www.maxspect.com.



Termini di garanzia

Maxspect Ltd. garantisce tutti i Sistemi di Illuminazione a LED Maxspect™ RSX per i difetti di fabbricazione, per un periodo di 12 mesi dalla data di acquisto. Se un difetto di produzione si presenta durante il periodo di garanzia, Maxspect Ltd. a sua discrezione, riparerà (usando componenti nuovi o ricostruiti) o sostituirà (con una nuova unità o rigenerate) il prodotto senza alcun costo.

LA GARANZIA NON SI APPLICA AL PRODOTTO SE È STATO DANNEGGIATO DA USO IMPROPRIO, ALTERAZIONE, INCIDENTE, USO O FUNZIONAMENTO IMPROPRIO, SE SONO EFFETTUATE RIPARAZIONI NON AUTORIZZATE.

ESCLUSIONE DEI DANNI INDIRETTI E ACCIDENTALI:

L'utilizzatore dei prodotti della Maxspect Ltd. non ha diritto ad alcun risarcimento danni diretti o indiretti, senza limitazione, derivanti da: disagi, danni ai beni personali, telefoni, le perdite materiali ecc... Questa garanzia conferisce diritti legali specifici.

MAXSPECT LTD. NON FORNISCE ALCUNA GARANZIA O DICHIARAZIONE, ESPLICITA O IMPLICITA, RISPETTO ALLA QUALITÀ DEL PRODOTTO, PRESTAZIONI, COMMERCIALIZZABILITÀ O IDONEITÀ PER UNO SCOPO DIVERSO DA QUELLO INDICATO. DI CONSEGUENZA QUESTO PRODOTTO VIENE VENDUTO, COSÌ COME È E L'ACQUIRENTE SI ASSUME IL RISCHIO SULLA QUALITÀ E PRESTAZIONI.

In nessun caso la MAXSPECT LTD potrà essere ritenuta responsabile per danni diretti, indiretti, speciali, incidentali o conseguenti derivanti da qualsiasi problema del prodotto o la documentazione.

La garanzia, ed i rimedi di cui sopra sono esclusivi e sostituiscono tutti gli altri, orali o scritti, espressi o impliciti. In nessun caso qualsiasi commerciante, agente, impiegato è autorizzato ad apportare modifiche, estensioni o aggiunte alla presente garanzia.

Alcuni stati non consentono l'esclusione o la limitazione delle garanzie implicite o la responsabilità per danni incidentali o consequenziali, pertanto la suddetta limitazione o esclusione potrebbe non applicarsi a Voi.

Impostazioni preimpostate

Preset 1

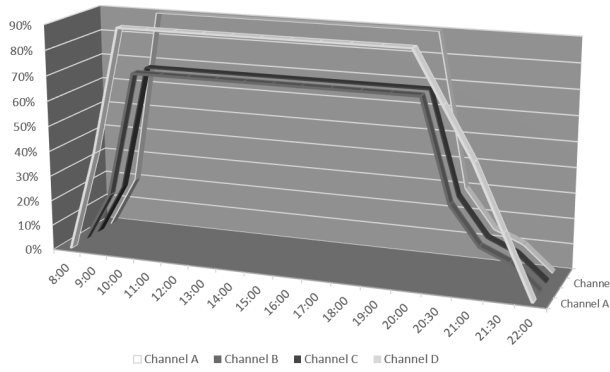

Preset 2

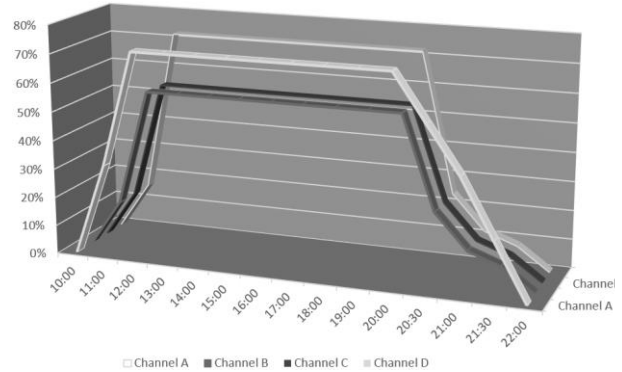

Preset 3

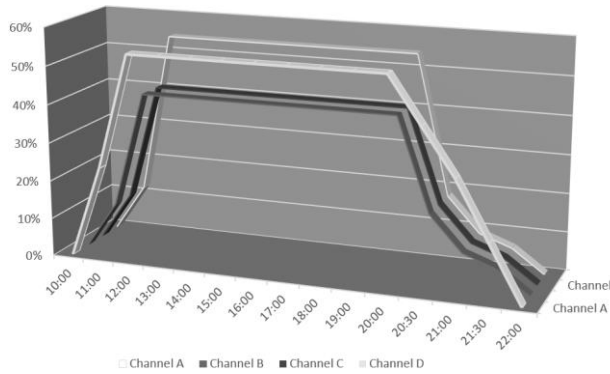

Preset 4

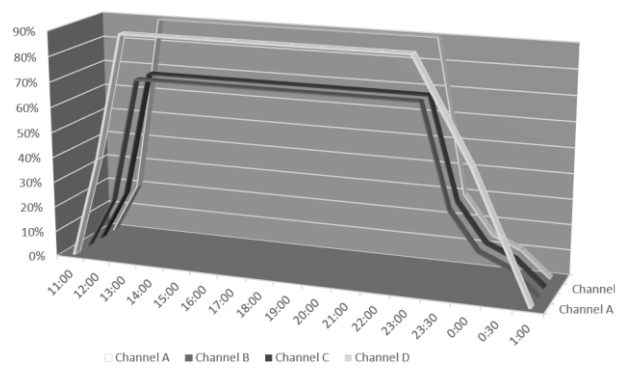

Italiano

Prezado Cliente,

Obrigado por adquirir este produto.

Para um melhor desempenho e segurança, por favor leia cuidadosamente estas instruções.

User Memo:

Data da Compra: _____

Nome Loja: _____

Endereço Loja: _____

Website Loja: _____

Email Loja: _____

Telefone Loja: _____

Português

Por favor, visite-nos no Facebook ou Twitter!



<https://www.facebook.com/Maxspect>



<http://twitter.com/maxspectled>

Conteúdo da Embalagem

Por favor, analise o conteúdo da embalagem.

R5-100

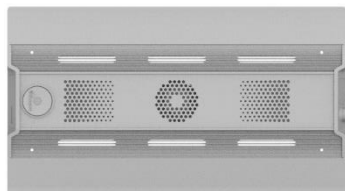

R5-150

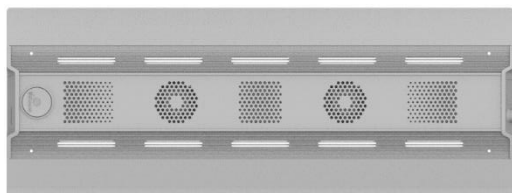

R5-200

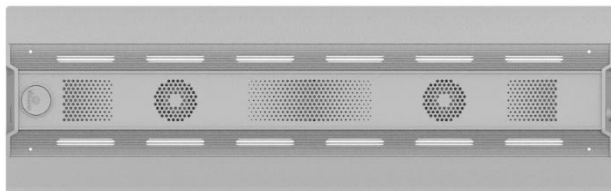

R5-300

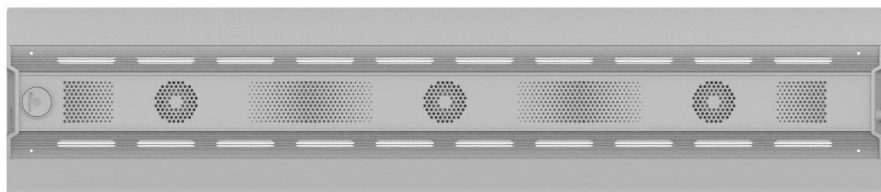

Português

Alimentation

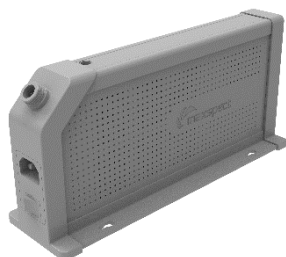

câble d'alimentation



PVC Adesivo

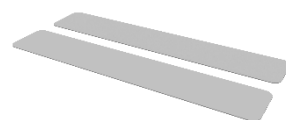

Support pour aquarium



Vis manuelles

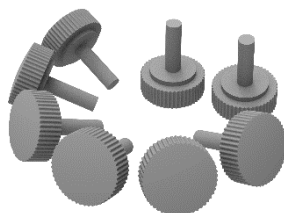

vis

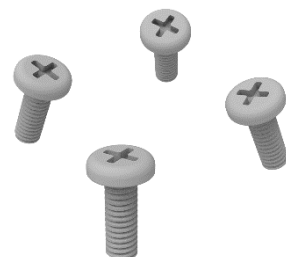

Antes de usar seu Sistema de Iluminação LED Maxspect™ RSX por favor leia este manual de instruções cuidadosamente. Tenha cuidado e siga corretamente todas as instruções descritas.

Mantenha sempre ao alcance este manual para eventual consulta.

Antes de usar seu Sistema de Iluminação LED Maxspect™

1. Remova todo o plástico e material de proteção da embalagem.
2. Nunca olhe diretamente para os leds quando você ligar a luminária. O uso incorreto do sistema poderá acarretar problemas de visão.

Segurança

1. **Fonte de energia** - Não anule a finalidade de segurança da tomada ou do tipo terra. Uma tomada polarizada possui duas lâminas, uma mais larga que a outra. Uma tomada de tipo terra tem duas lâminas e um terceiro pino de aterramento. A lâmina larga ou o terceiro pino são fornecidos para sua segurança. Se a tomada não encaixar na sua tomada, consulte um profissional da área para a substituição da tomada obsoleta.
2. **Proteção do cabo de energia** – Os cabos de alimentação devem ser instalados em locais que não são susceptíveis de serem pisados ou esmagados por elementos colocados sobre ou contra eles. Nunca segure a tomada ou o cabo se sua mão estiver molhada.
3. **Instalação** – Instale somente em ambientes fechados e/ou cobertos, usar os acessórios, peças de montagem, kit pendant e acessórios fornecidos e especificados pelo fabricante.

Português

Em funcionamento:

1. **Funcionamento** – Siga sempre as instruções de operação estabelecidas neste manual ao usar seu Sistema de Iluminação LED RSX Sistema de Iluminação LED.
2. **Calor** – O aparelho deve ser colocado longe de fontes de calor, como radiadores, e não expor ao calor excessivo, como luz solar, fogo ou algo semelhante.
3. **Umidade** – Para reduzir o risco de incêndio ou choque elétrico, não exponha o aparelho à chuva, umidade ou respingos.
4. **Ventilação** – O aparelho deve ser posicionado de modo que a sua localização ou posição não interfira com uma ventilação adequada.
5. **Magnetismo** – O aparelho deve ser mantido longe de equipamentos ou fontes que possam gerar forte magnetismo.
6. **Limpeza** – Limpe sempre com um pano seco.

Montagem do sistema RSX LED Lighting System

Antes de ligar o módulo de LED com a fonte de alimentação, monte o sistema, usando o(s) suporte(s) fornecido.

1. Montagem sobre o aquário.

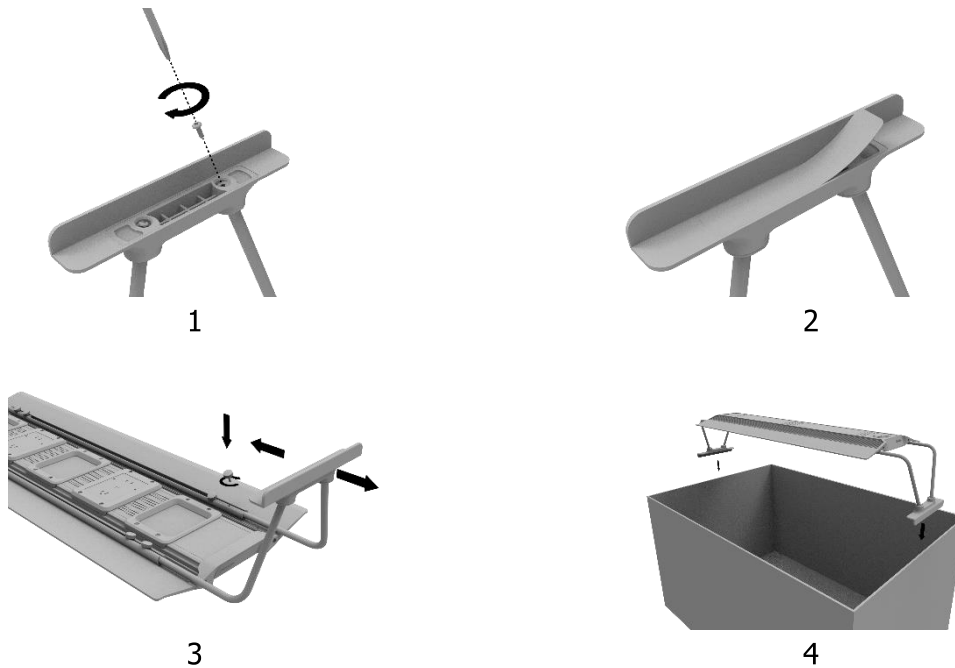

2. Montagem com pendante (kit vendido separadamente).

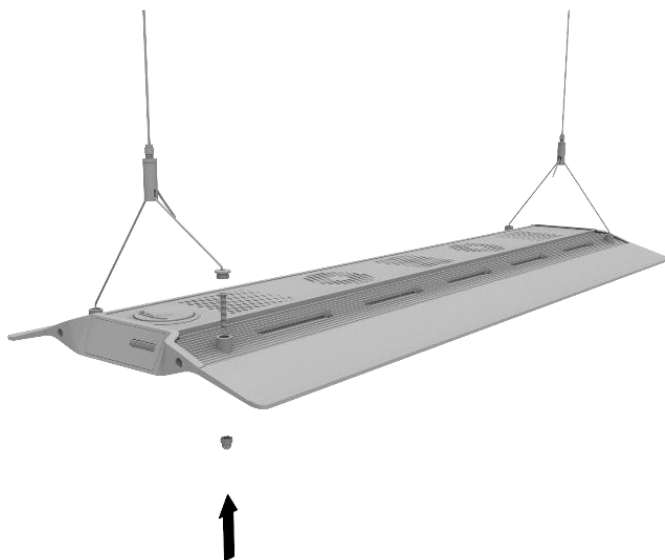

Instruções de funcionamento

Controlador integrado

A RSX pode ser controlada diretamente com o controlador integrado. O controlador possui um monitor OLED e um seletor de controle, a partir do qual o usuário pode configurar todas as funções para o dispositivo.



Padrão ou Master / Modo Slave

No caso de existirem duas ou mais unidades da luminária RSX, o usuário poderá conectá-los juntos através do modo Master / Slave para controlá-los simultaneamente todas as luminárias, onde as programadas como escravo seguirão as configurações programadas do Master, economizando tempo e esforço na programação de várias luminárias.

Português

Controle com dispositivos iOS ou Android (Opcional)

A RSX também pode ser ligada sem fios a um controlador ICV6 (vendido separadamente), o que permite que as luminárias Recuve sejam controladas por dispositivos iOS ou Android através do Sistema Syna-G.



Instruções de funcionamento

Operações básicas

Siga as instruções abaixo para operar e programar o módulo de LED RSX.

O módulo de LED liga-se automaticamente quando a alimentação é conectada, e, desliga quando a energia é cortada.

Quando a energia é restabelecida, o módulo de LED irá restaurar a configuração anterior que foi salva automaticamente, se a última colocação no modo Manual, Preset Mode ou Automática, e no nível de intensidade de todos os canais de LED de quando a energia foi cortada.

O ventilador na luminária RSX mantém a temperatura controlada.

A RSX tem um sistema interno de controle de temperatura. O ventilador será automaticamente ligado quando a temperatura estiver acima de 55°C/131°F, e desligado quando estiver abaixo de 45°C/113°F.

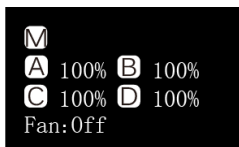

Abaixo 45°C/113°F

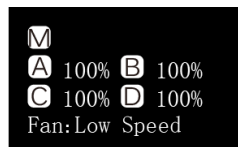

Acima 55°C/131°F

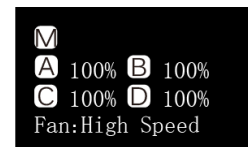

Acima 65°C/149°F

Se o ventilador falhar, o sistema poderá superaquecer e entrará no modo de segurança quando a temperatura estiver acima de 80°C/176°F, desligando todos os canais. O sistema sairá do modo de segurança contra falhas e retomará ao funcionamento normal quando a temperatura desça abaixo de 70°C/158°F.

Alternar entre Modo Auto e Manual

A RSX tem dois modos de operação: Auto e Manual. O usuário pode alternar entre os dois modos com o seletor de controle da luminária.



- Pressione e mantenha pressionado o botão de controle durante 3 segundos para mudar para outro modo.

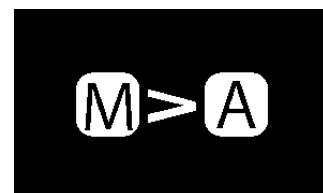

Instruções de funcionamento

Modo Manual

- Pressione o botão de controle para entrar no ajuste.
- Pressione o botão de controle novamente para alternar entre os canais.
- Gire o dial de controle para definir o brilho de cada canal de LED.
- Pressione e mantenha pressionado o botão de controle durante 3 segundos para guardar a definição e sair da página.

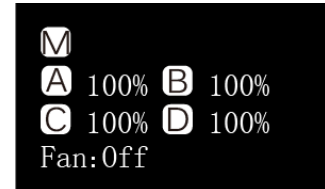

Modo Automático

- Pressione o botão de controle para entrar no ajuste.
- Gire o dial de controle para alternar entre as configurações.
- Pressione e mantenha pressionado o botão de controle durante 3 segundos para guardar a definição e sair da página.

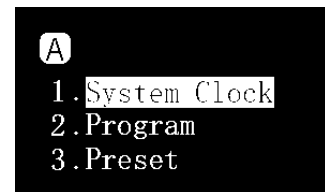
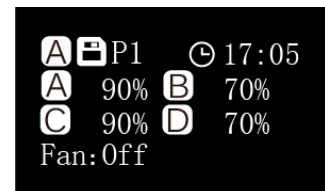

No Modo Automático, existem três configurações para que o usuário selecione:

System Clock: Um relógio configurado para ser combinado com a hora local dos usuários.

Program: Programe o fotoperíodo para definir brilho específico para cada canal de LED durante diferentes horas do dia.

Preset: 4 configurações predefinidas estão disponíveis para o usuário escolher. (Consulte a página 80)

P1: Aquário de SPS.

P2: Aquário Misto SPS/LPS.

P3: Aquário Misto Corais Soft/LPS.

P4: Aquário de SPS com diferente

amanhece/anoitecer com luz da lua.

Ajuste de horário

- Pressione o botão de controle para entrar na página de configuração e selecione "System Clock".
- Pressione o botão de controle para alternar entre hora e minuto.
- Gire o dial para ajustar a hora.
- Pressione e mantenha pressionado o botão de controle durante 3 segundos para guardar a definição e sair da página.

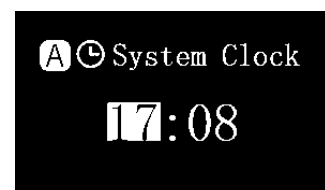
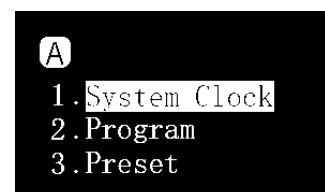

Instruções de funcionamento

Compreendendo o Time Point

Há um total de 24 Time Points. É possível programar intensidade de saída luminosa diferente em cada ponto de tempo para controlar o fotoperíodo e o brilho do sistema.

Tome Preset P1 como um exemplo, é uma configuração para aquário SPS. O fotoperíodo começa às 08:00 onde o sistema aumenta a luz gradualmente, picos às 10:00 e permanece das 10:00 às 20:00 antes que o sistema diminua gradualmente a luz até que seja desligado em 22:00, com a luz da lua ligada.

	TP01	TP02	TP03	TP04	TP05	TP06	TP07	TP08
	08:00	09:00	10:00	20:00	20:30	21:00	21:30	22:00
Channel A	0%	40%	90%	90%	70%	50%	25%	0%
Channel B	0%	20%	70%	70%	30%	15%	10%	0%
Channel C	1%	20%	70%	70%	30%	15%	10%	1%
Channel D	0%	20%	90%	90%	30%	15%	10%	0%

O diagrama abaixo ilustra como os dois canais de LED se comportaria uma vez que os pontos de tempo acima foram programados.

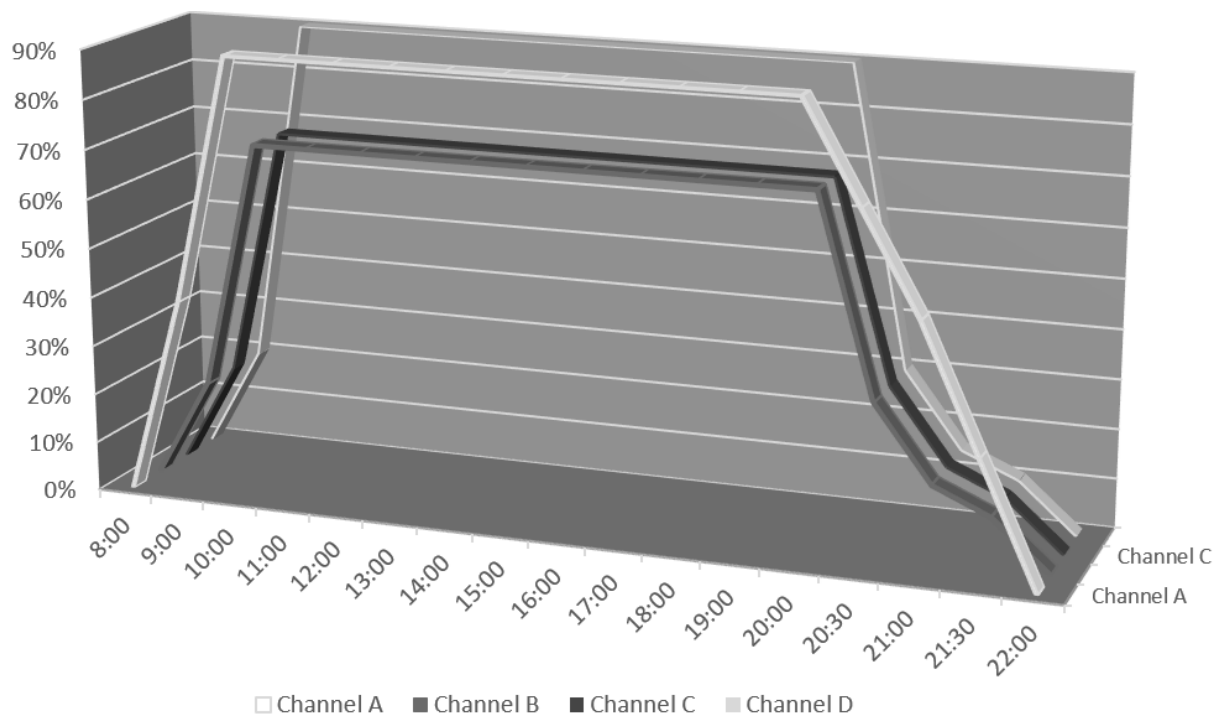

Instruções de funcionamento

Programando Fotoperíodo

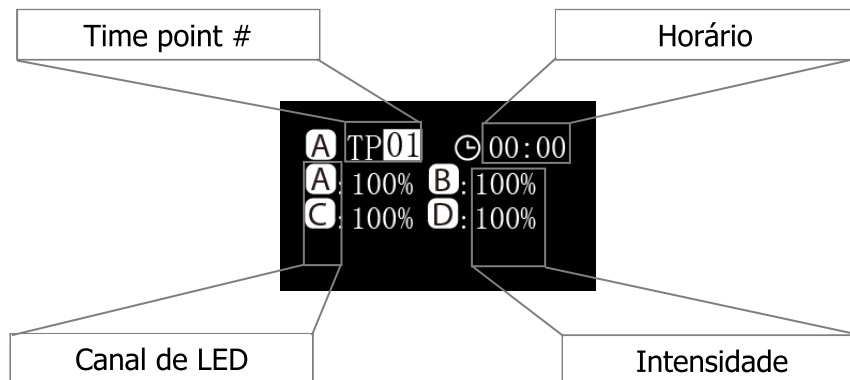

Modificar

- Pressione o botão de controle para alternar entre os parâmetros.
- Gire o dial de controle para ajustar o parâmetro.
- Pressione e mantenha pressionado o botão de controle durante 3 segundos para passar para a página seguinte.

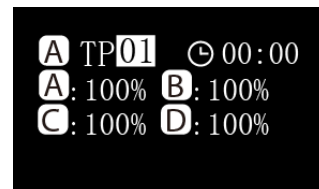

Aplicar

- Gire o dial de controle para selecionar "Apply".
- Pressione o botão de controle para guardar a definição.
- Pressione e mantenha pressionado o botão de controle durante 3 segundos para regressar ao menu principal.



Visualização

- Gire o dial de controle para selecionar "Preview".
 - Pressione o dial de controle para executar o programa no modo de visualização, onde todo o fotoperíodo é demonstrado em 3 minutos.
 - Pressione e mantenha pressionado o botão de controle durante 3 segundos para regressar ao menu principal.
-
- Gire o dial de controle para selecionar "Modify".
 - Pressione para reajustar os parâmetros, veja "Modify" acima.



Instruções de funcionamento

Selecionar Preset

- Gire o dial de controle para alternar entre as predefinições.
- Pressione o botão de controle para voltar para a próxima página.

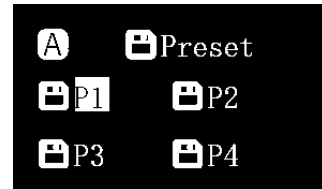

Aplicar

- Gire o dial de controle para selecionar "Apply".
- Pressione o botão de controle para guardar a definição.



Visualização

- Gire o dial de controle para selecionar "Preview".
- Pressione o dial de controle para executar o programa no modo de visualização, onde todo o fotoperíodo é demonstrado em 3 minutos.
- Pressione e mantenha pressionado o botão de controle durante 3 segundos para regressar ao menu principal.

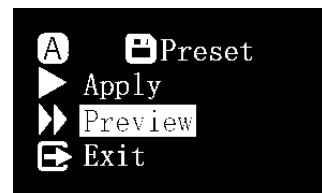

- Rode o botão de controle para selecionar "Exit".
- Pressione o botão de controle para voltar ao menu principal.



Instruções de Manutenção

Configuração do Sistema

A Configuração do Sistema possui um conjunto de funções que permitem ao usuário executar a manutenção no dispositivo.

Para entrar na página de Configuração do Sistema, primeiro desligue o dispositivo elétrico e, em seguida, pressione e mantenha pressionado o botão de controle enquanto o dispositivo volta a ser ligado. Mantenha pressionado o botão de controle até que a página de configuração do sistema seja exibida no monitor OLED.

Existem 7 funções na tela Configuração do Sistema.

1. Firmware (Firmware)
2. Restore (Restaurar)
3. Reset (Resetar)
4. Test Mode (Modo Teste)
5. Model Number (Numero do Modelo)
6. Standard or Master/Slave mode (Seleção de Modo)
7. Exit (Sair)

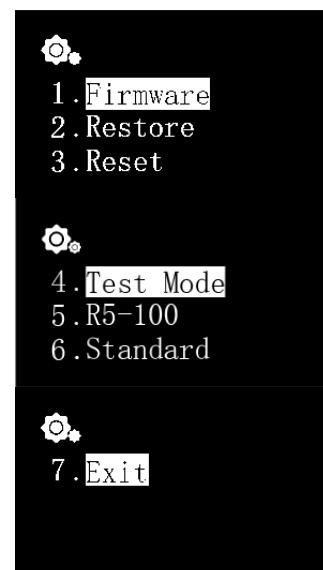

Português

1. Firmware

Esta função permite ao usuário atualizar o firmware.

- Gire o dial de controle para selecionar "Firmware".
- Pressione o dial de controle para iniciar a atualização do firmware.
- Quando não houver um cartão TF(micro SD) ou um firmware inválido no cartão TF, "NO TF Card" ou "Wrong File" será mostrado.
- Caso contrário, o progresso da atualização do firmware será mostrado.
- Após atualização do firmware com sucesso, o dispositivo será reiniciado automaticamente e o novo número de versão do firmware será mostrado.

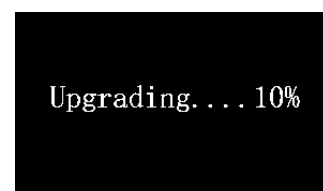

Instruções de Manutenção

2. Restore

Esta função permite ao usuário restaurar o firmware para sua versão original de fábrica. Após concluir a restauração do firmware, o dispositivo será reiniciado automaticamente e o número da versão do firmware será mostrado.

- Rode o disco de controle para seleccionar "Restore".
- Pressione o dial de controle para restaurar o firmware.



3. Reset

Esta função permite ao usuário reinicializar o dispositivo de volta às suas configurações de fábrica. Depois de terminar de redefinir o dispositivo, ele será reiniciado automaticamente.

- Gire o seletor de controle para seleccionar "Reset".
- Pressione o botão de controle para redefinir a fábrica.



4. Test Mode

Esta função permite que o usuário coloque a luminária no modo de teste, o que ajudaria nosso representante de atendimento ao cliente diagnosticar o dispositivo. **Isso só deve ser feito pelos usuários quando informado pelo revendedor autorizado ou representante do cliente para realizar determinado teste na luminária.**

5. Model Number

Esta função exibirá o número do modelo da luminária, que também serve como nome do ID quando a RSX está conectada a um dispositivo iOS ou Android através do sistema Syna-G. **Em circunstâncias normais, este valor não poderá ser alterado.**

Instruções de Manutenção

6. Standard or Master/Slave Mode

Esta função permite que o usuário escolha entre o modo de operação Standard stand-alone, ou Master/Slave onde várias unidades de dispositivos RSX podem ser conectadas em conjunto.

Uma vez conectados, todos os dispositivos escravos seguirão as configurações programadas no equipamento Master, economizando tempo e esforço na configuração de várias luminárias.

O valor padrão é "Standard", significando que o dispositivo está sendo executado no modo de operação autônomo.

Quando a RSX é definida como unidade Master, ela precisará atribuir um canal de 01 a 10. Todas as unidades escravo de conexão devem ser atribuídas ao mesmo canal.

No caso em que vários grupos de Master/Slave coexistem em uma proximidade, cada unidade mestre deve atribuir um canal diferente para evitar interferência com outro grupo.

- Gire o dial de controle para selecionar "Standard".
- Pressione o botão de controle para entrar na página de configuração.
- Gire o dial de controle para atribuí-lo como uma unidade "Master" ou "Slave".
- Após selecionar a unidade Master/Slave, pressione o botão de controle para atribuir um canal.
- Pressione e mantenha pressionado o botão de controle durante 3 segundos para guardar a definição.



7. Exit

- Pressione "Exit" para reiniciar o dispositivo.

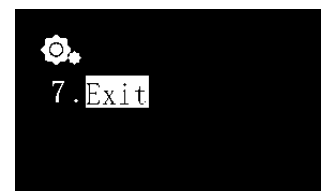

Manutenção do Equipamento

O usuário deve realizar periodicamente a manutenção do equipamento, incluindo mas não se limitando aos seguintes passos:

- Usando um pano úmido para limpar a lente de acrílico para certificar-se de que ele não é coberto por respingo com sal ou outras sujeira e detritos. As lentes não limpas afetarão gravemente a saída luminosa do aparelho, portanto, para obter o melhor desempenho, você deve limpar a lente uma vez por semana.
- Limpe a poeira e detritos presos nas unidades de ventilação. Ventiladores devidamente limpos trabalham melhor e com tempo de vida mais longo. As unidades de ventilação são peças de desgaste e devem ser substituídas a cada 24-36 meses, dependendo da frequência de manutenção realizada.
- Limpe / remova qualquer acúmulo de sal ou sujeira e detritos que tenham sido acumulados ou recolhidos no corpo de alumínio do aparelho, pois podem afetar a dissipação de calor do equipamento.

Nota: A falha em realizar a manutenção acima mencionada pode causar danos desnecessários ao equipamento e como conseqüentemente anular a garantia!

Português

ATENÇÃO:

Para especificações mais recentes dos LEDs, tipos e espectro de cores, por favor, visite nosso website em www.maxspect.com



Maxspect Ltd. garante ao produto Sistema de Iluminação LED Maxspect™ RSX a garantia de 12 meses relacionados com defeitos de fabricação, sendo contados a partir da data de compra. Se houver algum defeito no produto durante o período de garantia, a Maxspect realizará o reparo no equipamento (com peças novas) sem nenhum custo.

A garantia não se aplica ao produto que foi submetido a mau uso, manipulado por pessoas não autorizadas (técnicos ou não), usado de forma inadequada (instalação, local inadequado), alteração na configuração dos leds ou qualquer tipo de queda do produto que possa causar danos ao mesmo.

ISENÇÃO DE DANOS E CONSEQÜÊNCIAS:

Você e qualquer outro usuário dos produtos Maxspect Ltd. não terá direito a quaisquer danos acidentais, incluindo, sem limitação, perda de uso da unidade, inconveniência, danos a bens pessoais, telefonemas, perda de renda ou lucros. Esta garantia lhe dá direitos legais específicos.

MAXSPECT LTD. NÃO FAZ NENHUMA GARANTIA OU REPRESENTAÇÃO, EXPRESSA OU IMPLÍCITA, COM RELAÇÃO À QUALIDADE DO PRODUTO, DESEMPENHO, COMERCIALIZAÇÃO OU ADEQUAÇÃO PARA UM DETERMINADO PROPÓSITO. COMO RESULTADO, ESTE PRODUTO, É VENDIDO "COMO ELE É", E VOCÊ O COMPRADOR ASSUME O RISCO TOTAL COM A SUA QUALIDADE E DESEMPENHO.

EM HIPÓTESE ALGUMA MAXSPECT LTD SÃO RESPONSÁVEIS DIRETOS, INDIRETOS, ESPECIAIS, INCIDENTAIS OU CONSEQÜENCIAIS DECORRENTES DE QUALQUER DEFEITO NO PRODUTO OU SUA DOCUMENTAÇÃO.

A garantia, aviso legal, e soluções estabelecidas acima são exclusivas. A substituir todos os outros, oral ou escrita, expressa ou implícita. Em nenhum momento, quaisquer negociantes Maxspect Ltd., agentes ou funcionários serão autorizados a fazer qualquer modificação, extensão ou acréscimo a esta garantia.

Alguns estados não permitem a exclusão ou limitação de garantias implícitas ou de responsabilidade por danos acidentais ou consequentes, portanto a limitação ou exclusão acima pode não se aplicar a você.

Configurações predefinidas

Preset 1

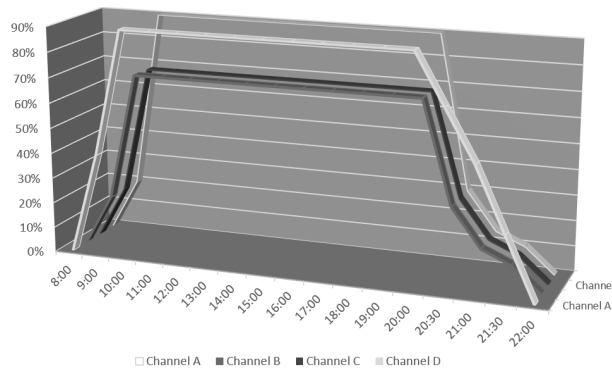

Preset 2

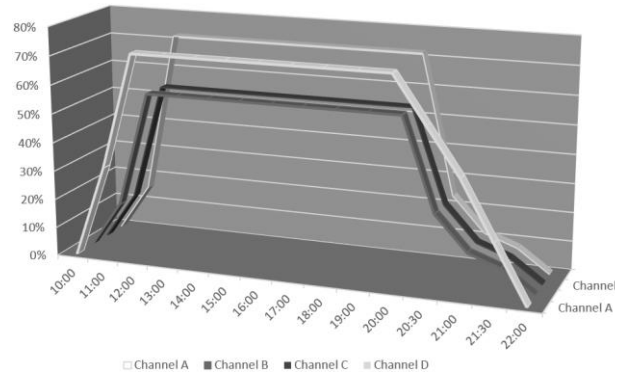

Preset 3

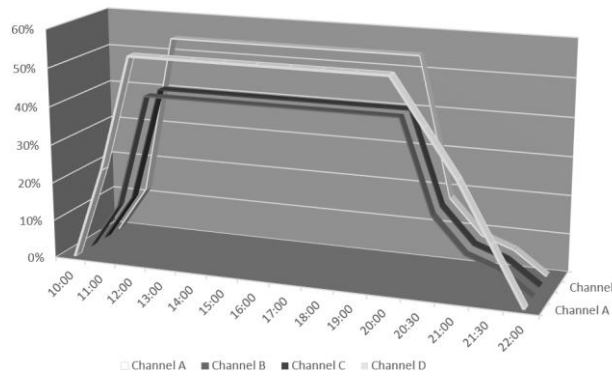

Preset 4

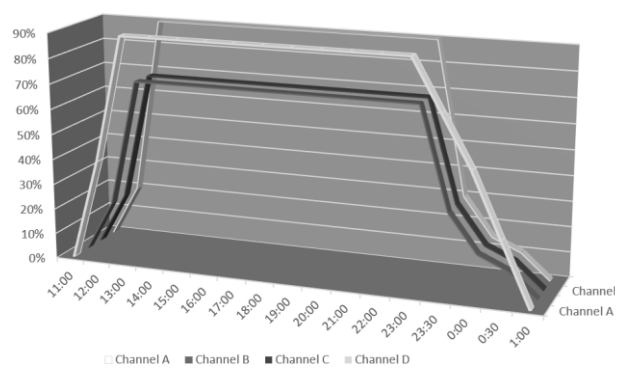

Português

Szanowny Kliencie,

Dziękujemy i gratulujemy za zakup naszego produktu.

Prosimy o uważne przeczytanie poniższych instrukcji w celu uzyskania optymalnej wydajności i bezpieczeństwa.

User Memo:

Data zakupu: _____

Sprzedawca: _____

Adres sprzedawcy: _____

Strona web
sprzedawcy: _____

E-mail sprzedawcy: _____

Telefon sprzedawcy: _____

Polski

Odwiedz nas na Facebook i Twitter!



<https://www.facebook.com/Maxspect>



<http://twitter.com/maxspectled>

Zawartość opakowania

Proszę sprawdzić zawartość opakowania.

R5-100

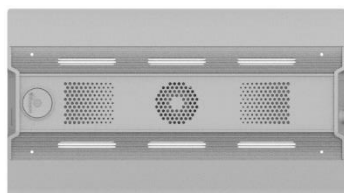

R5-150

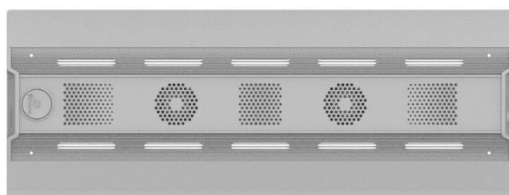

R5-200

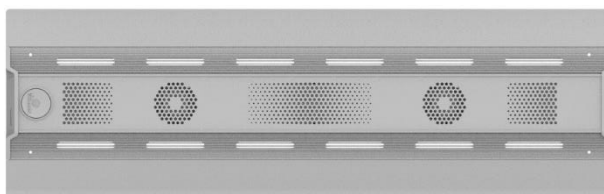

R5-300



Alimentation

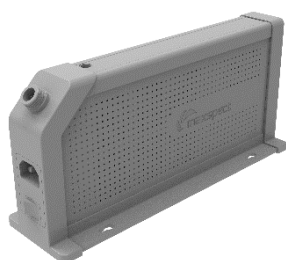

câble d'alimentation



PVC Naklejka

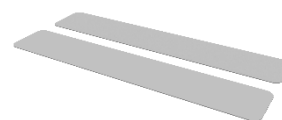

Support pour aquarium



Vis manuelles

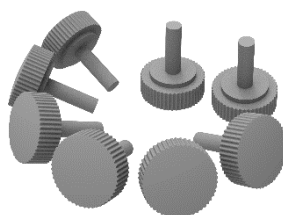

Vis

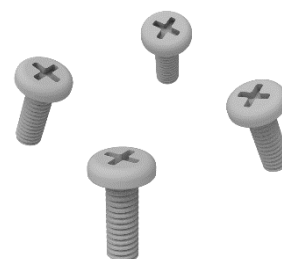

Środki ostrożności

Proszę o uważne przeczytanie poniższych instrukcji obsługi przed użyciem zestawu oświetleniowego LED Maxspect™ RSX. Proszę zwrócić szczególną uwagę na zawarte poniżej instrukcje.

Prosimy o przechowanie podręcznika do wykorzystania w przyszłości.

Przed użyciem ledowego systemu oświetleniowego Maxspect™

1. Usunąć wszelkie opakowania / ofoliowanie, które chronią lampę i inne części zestawu.
2. Nie spoglądać nigdy bezpośrednio na diody LED po włączeniu systemu oświetleniowego. Niepoprawne używanie aparatu zwiększa ryzyko uszkodzenia wzroku.

Bezpieczeństwo

1. Zasilanie – nie anulować uziemienia wtyczki. Jeśli wtyczka nie pasuje do gniazdka, prosimy o skontaktowanie się z elektrykiem w celu wymiany gniazdka na odpowiednie.
2. Przewody zasilające powinny być prowadzone sposobem uniemożliwiającym chodzenie po nich bądź przysięganie przedmiotami umieszczonymi w ich pobliżu bądź nad nimi. Nigdy nie chwytac wtyczki i kabla zasilającego mokrą ręką; nie ciągnac kabla a chwytac za wtyczkę w celu jej odłączenia lub podłączenia.
3. Oświetlenie nadaje się tylko do użytku wewnątrz lokali, nie instalować na zewnątrz; do instalacji używać wyłącznie elementów przewidzianych i dostarczonych przez producenta.

Użytkowanie

1. **Użytkowanie** – podczas użytkowania ledowego systemu oświetleniowego RSX stosować się zawsze do instrukcji obsługi zawartych w poniższym podręczniku
2. **Temperatura** – urządzenie powinno być umieszczone z dala od źródeł ciepła, takich jak kaloryfery; nie wystawiać na nadmierne działanie promieni słonecznych, ognia itp.
3. **Wilgoc** – aby zmniejszyć ryzyko pożaru oraz porażenia prądem nie narażać urządzenia na działanie deszczu, wilgoci, kapiącej wody bądź chlapania wodą.
4. **Wentylacja** – urządzenie powinno być umieszczone w miejscu gwarantującym swobodny przepływ powietrza.
5. **Pole magnetyczne** – aparat powinien być umieszczony z dala od sprzętu i urządzeń generujących silne pole magnetyczne.
6. **Czyszczenie** – czyścić często używając wyłącznie suchej miękkiej szmatki. Przed czyszczeniem odłączyć z sieci zasilania.

Montaż ledowego systemu oświetleniowego RSX

Przed podłączeniem oświetlenia RSX do sieci elektrycznej przeprowadzić całkowity montaż struktury przy użyciu stojaka.

1. Stelaż na akwarium

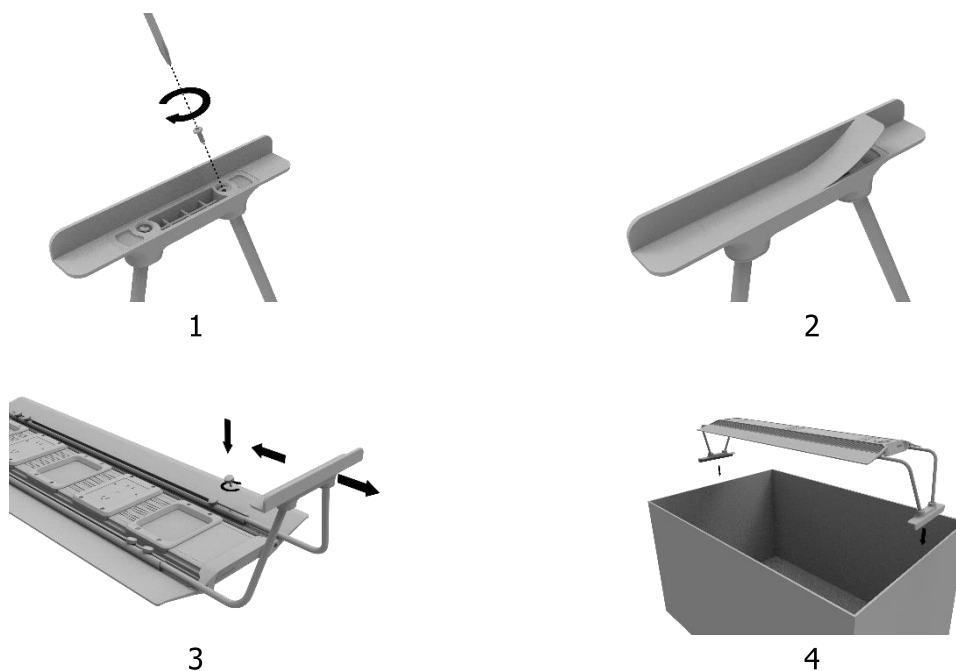

2. Linki do zawieszenia (Zestawy wiszące sprzedawane oddzielnie)

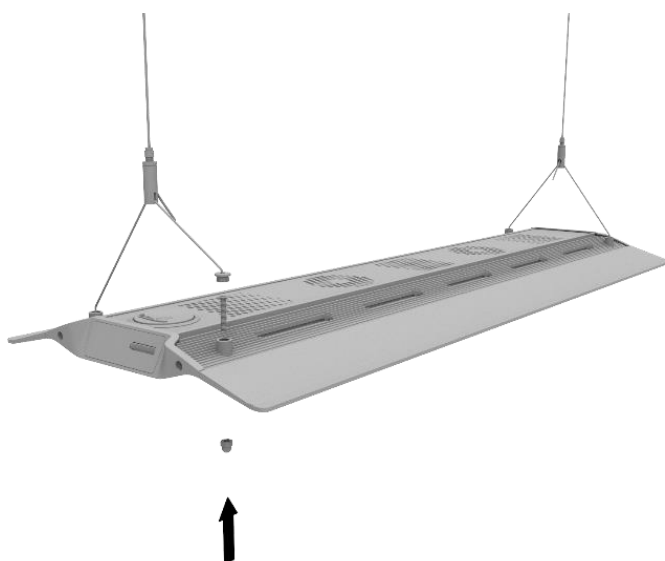

Wbudowany kontroler

RSX może być sterowany bezpośrednio dzięki wbudowanemu kontrolerowi. Wbudowany kontroler posiada wyświetlacz OLED i pokrętkę nastawiania, przy użyciu którego użytkownik może ustawiać i regulować wszystkie funkcje lampy.



Tryb Standardowy lub Master/Slave

Zakładając że posiadamy 2 lub więcej jednostek RSX, użytkownik może połączyć je razem dzięki trybowi Master/Slave by móc kontrolować je jednocześnie – wszystkie jednostki Slave będą działać zgodnie z programem ustawionym na lampie Master, dzięki czemu zaoszczędzamy na czasie i wysiłku przy ustawianiu wielu jednostek.

Kontrola przy użyciu iOS lub Android (Opcjonalne)

RSX może także zostać połączony bezprzewodowo z kontrolerem ICV6 (sprzedawany oddzielnie), co pozwala kontrolować lampy RSX przez urządzenia iOS lub Android przez Syna-G System.



Obsługa podstawowa

Prosimy postępować wg poniższych instrukcji w celu włączenia i oprogramowania modułu RSX.

Moduł RSX włącza się automatycznie po podłączeniu do sieci zasilania i wyłącza po odcięciu od prądu.

W przypadku odcięcia modułu od prądu i ponownego podłączenia do zasilania wprowadzone wcześniej ustawienia przywracane są automatycznie.

Wentylator lampy RSX jest kontrolowany przez termostat.

RSX posiada wbudowany termostat. Wentylator zostanie automatycznie włączony gdy temperatura przekroczy 55°C, a wyłączy się gdy spadnie poniżej 45°C.

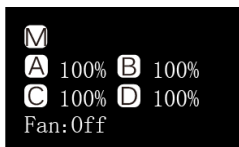

Poniżej 45°C/113°F

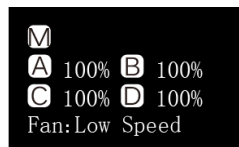

Przekroczy 55°C/131°F

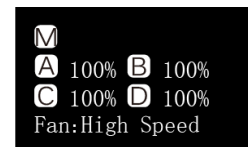

przekroczy 65°C/149°F

Jeśli wentylator ulegnie awarii, system może się przegrzać i przejść w tryb fail-safe gdy temperatura przekroczy 80°C, wyłączając wszystkie kanały. System wyjdzie z trybu fail-safe i powróci do normalnej pracy gdy temperatura spadnie poniżej 70°C.

Przełączanie pomiędzy trybem Auto i Manualnym

RSX posiada dwa tryby pracy: Auto oraz Manualny. Użytkownik może przełączać pomiędzy nimi przy użyciu pokrętki nastawnej lampy.



- Naciśnij i przytrzymaj pokrętkę nastawne przez 3 sekundy by przełączać tryby.

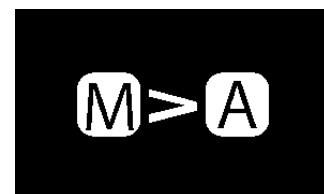

Tryb Manualny

- rzyciśnij pokrętko nastawne by wejść w ustawienia.
- Naciśnij pokrętko nastawne jeszcze raz by przełączać kanały.
- Obracaj pokrętko nastawne by dostosować jasność poszczególnych kanałów LED.
- Naciśnij i przytrzymaj pokrętko nastawne przez 3 sekundy by zapisać ustawienia i wyjść z menu.



Tryb Auto (Automatyczny)

- Przyciśnij pokrętko nastawne by wejść w ustawienia.
- Obracaj pokrętko nastawne by przeskakiwać pomiędzy opcjami.
- Naciśnij i przytrzymaj pokrętko nastawne przez 3 sekundy by zapisać ustawienia i wyjść z menu.

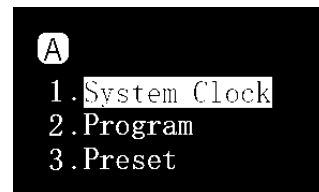
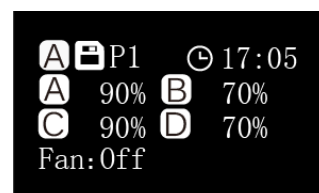

W trybie Automatycznym są dostępne 3 opcje modyfikowalne:

System Clock: Zegar do ustawienia z lokalnym czasem użytkownika.

Program: Programowanie Fotoperiodu by ustawić pożądaną jasność poszczególnych kanałów LED o różnym czasie dnia.

Preset: 4 fabryczne ustawienia dostępne do wyboru użytkownika. (Patrz strona 96)

P1: Zbiornik z przewagą SPS.

P2: Zbiornik mieszany SPS/LPS.

P3: Zbiornik mieszany korale miękkie/LPS.

P4: Zbiornik z przewagą SPS z innym czasem wschodu/zachodu oraz światłem księżycyca.

Ustawianie zegara

- Naciśnij pokrętko nastawne by wejść w Menu ustawień i wybierz „Zegar Systemowy”.
- Naciśnij pokrętko nastawne by przełączać pomiędzy godzinami a minutami.
- Obracaj pokrętko nastawne by ustawić czas.
- Naciśnij i przytrzymaj pokrętko nastawne przez 3 sekundy by zapisać ustawienia i wyjść z menu.

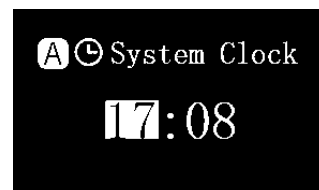
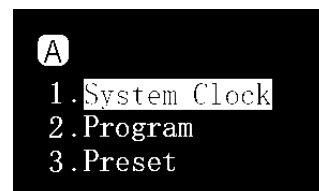

Wyjaśnienie Punktów Czasowych (Time Points)

Lampa posiada łącznie 24 Punkty Czasowe. Można programować intensywność świecenia w każdym Punkcie Czasowym by kontrolować fotoperiod i jasność lampy.

Weźmy Preset P1 jako przykład, jest to ustawienie dla zbiornika z przewagą SPS. Fotoperiod rozpoczyna się o 8:00 gdzie system zwiększa jasność stopniowo, osiąga szczyt o 10:00 i trwa 10 godzin do 20:00 zanim system stopniowo zacznie ściemniać światło aż wyłączy się o 22:00 i załączy światło księżycowe.

	TP01	TP02	TP03	TP04	TP05	TP06	TP07	TP08
	08:00	09:00	10:00	20:00	20:30	21:00	21:30	22:00
Kanał A	0%	40%	90%	90%	70%	50%	25%	0%
Kanał B	0%	20%	70%	70%	30%	15%	10%	0%
Kanał C	1%	20%	70%	70%	30%	15%	10%	1%
Kanał D	0%	20%	90%	90%	30%	15%	10%	0%

Poniższy diagram ilustruje sposób, w jaki 6 kanałów LED zachowywałoby się, gdy zaprogramowano powyższe Punkty Czasowe.

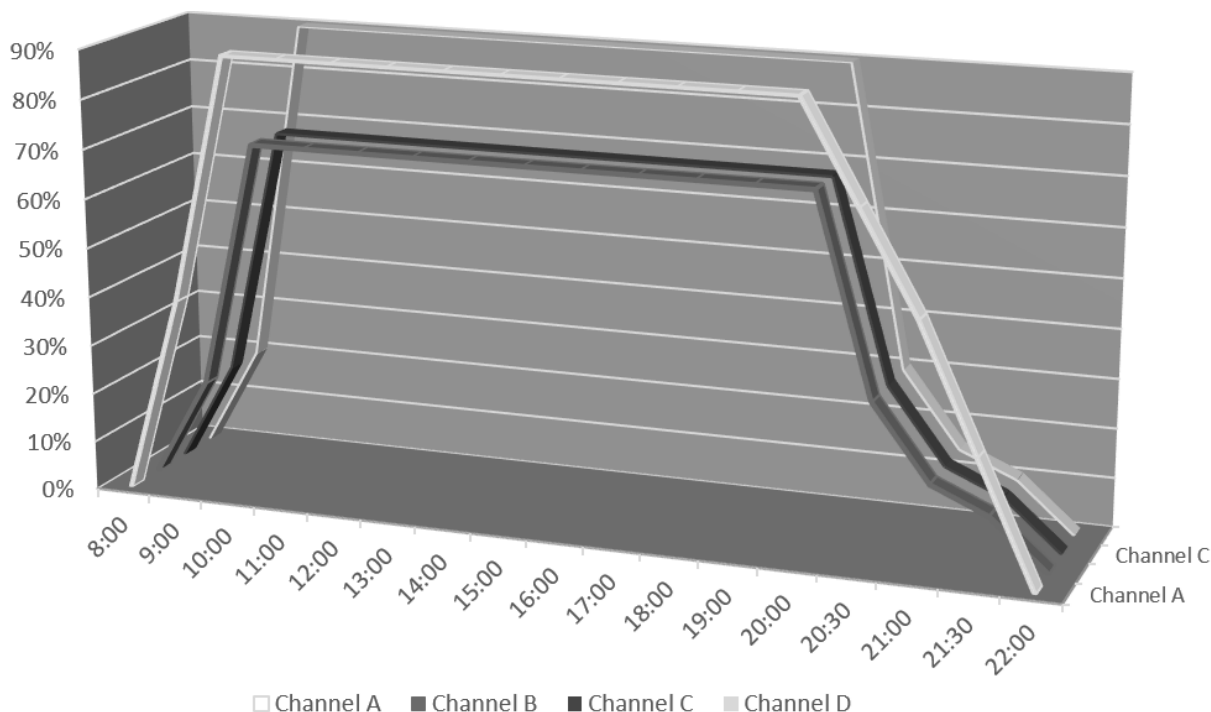

Programowanie Fotoperiodu

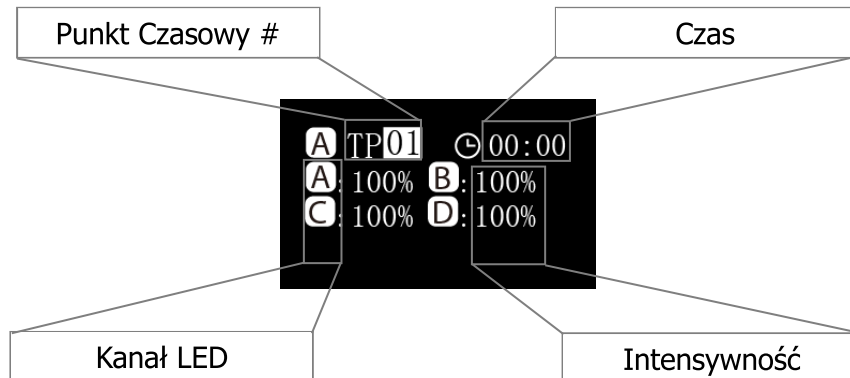

Modyfikuj

- Naciśnij pokrętkę nastawne by przełączać pomiędzy parametrami.
- Obracaj pokrętkę nastawne by ustawić parametry.
- Naciśnij i przytrzymaj pokrętkę nastawne przez 3 sekundy by przejść do następnej strony.

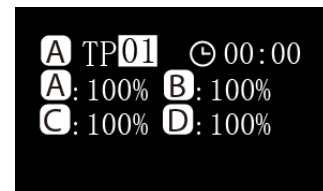

Zastosuj

- Obracając pokrętkę nastawne wybierz "Apply".
- Naciśnij pokrętkę nastawne by zapisać ustawienia.
- Naciśnij i przytrzymaj pokrętkę nastawne przez 3 sekundy by wrócić do menu głównego.



Podgląd

- Obracając pokrętkę nastawne wybierz "Preview".
- Naciśnij pokrętkę nastawne by uruchomić tryb demo , gdzie cały fotoperiod jest wyświetlany w 3 minuty.
- Naciśnij i przytrzymaj pokrętkę nastawne przez 3 sekundy by wrócić do menu głównego.



- Obracając pokrętkę nastawne wybierz "Modify".
- Naciśnij by zmienić ustawienia parametrów, patrz „Modyfikuj” powyżej.



Wybór Presetu

- Obracaj pokrętkę nastawne by przeskakiwać pomiędzy presetami.
- Naciśnij pokrętkę nastawne by przejść do następnej strony.

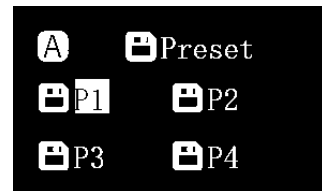

Zastosuj

- Obracając pokrętkę nastawne wybierz "Apply".
- Naciśnij pokrętkę nastawne by zapisać ustawienia.



Podgląd

- Obracając pokrętkę nastawne wybierz "Preview".
- Naciśnij pokrętkę nastawne by uruchomić tryb demo , gdzie cały preset jest wyświetlany w 3 minuty.
- Naciśnij i przytrzymaj pokrętkę nastawne przez 3 sekundy by wrócić do menu głównego.

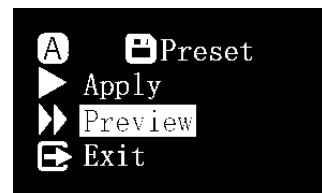

Exit

- Obróć pokrętkę nastawne i wybierz "Exit".
- Naciśnij pokrętkę nastawne by wrócić do Menu głównego.



Ustawienia Systemowe

Ustawienia Systemowe zawierają zestaw funkcji pozwalających użytkownikowi przeprowadzić konserwację lampy.

By wejść w stronę Ustawień Systemowych, najpierw wyłącz lampę, następnie naciśnij i przytrzymaj pokrętko nastawne jednocześnie włączając lampę ponownie. Przytrzymaj pokrętko nastawne aż strona Ustawień Systemowych wyświetli się na ekranie OLED.

W Ustawieniach Systemowych jest 7 opcji.

1. Firmware
2. Przywracanie
3. Reset
4. Tryb testowy
5. Numer Modelu
6. Tryb Standardowy lub Master/Slave
7. Wyjście

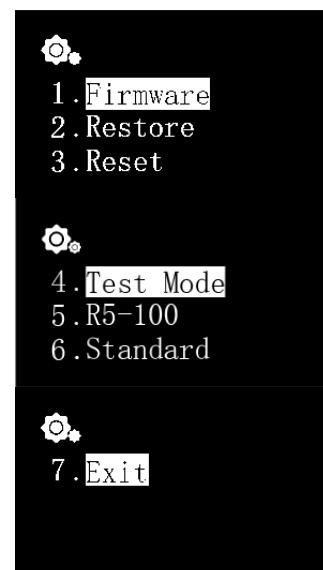

1. Firmware

Ta funkcja pozwala użytkownikowi dokonać aktualizacji firmware.

- Obróć pokrętko nastawne i wybierz „Firmware”.
- Naciśnij pokrętko nastawne by rozpocząć aktualizację firmware.
- Jeśli nie ma karty TF(micro SD) albo jest na niej nieprawidłowy plik firmware, informacja „Brak karty TF” lub „Zły plik” zostanie wyświetlona.
- W każdym innym przypadku postęp aktualizacji będzie wyświetlany.
- Kiedy proces aktualizacji zakończy się pomyślnie, lampa zostanie uruchomiona ponownie a numer wersji nowego firmware zostanie wyświetlony.

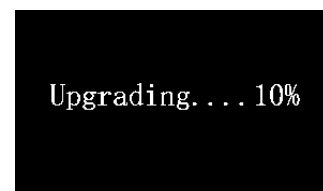

2. Przywracanie

Ta funkcja pozwala użytkownikowi przywrócić oryginalne firmware lampy. Po przywróceniu firmware do oryginalnego stanu, lampa zostanie uruchomiona ponownie a numer firmware zostanie wyświetlony.

- Obróć pokrętko nastawne i wybierz "Restore".
- Naciśnij pokrętko nastawne by przywrócić firmware.



3. Reset

Ta funkcja pozwala użytkownikowi przywrócić ustawienia fabryczne lampy. Po przywróceniu ustawień, lampa uruchomi się ponownie.

- Obróć pokrętko nastawne i wybierz "Reset".
- Naciśnij pokrętko nastawne by przywrócić ustawienia fabryczne.



4. Tryb testowy

Ta funkcja pozwala użytkownikowi ustawić lampę w tryb testowy, co pomoże naszemu przedstawicielowi obsługi klienta zdiagnozować lampę. **To powinno być dokonywane tylko za poleceniem autoryzowanego dealera lub przedstawiciela obsługi klienta by przeprowadzać pewne testy na urządzeniu.**

5. Numer Modelu

Ta funkcja wyświetla numer modelu lampy, który także jest nazwą ID gdy RSX jest połączony z urządzeniem iOS lub Android przez system Syna-G. **W normalnych okolicznościach nie należy modyfikować tej wartości.**

Instrukcje Konserwacja

6. Tryb Standardowy lub Master/Slave

Ta funkcja pozwala użytkownikowi wybrać pomiędzy trybem Standardowym w którym lampa działa samodzielnie lub Master/Slave gdzie wiele lamp RSX może być połączonych razem.

Podczas połączenia wszystkie lampy Slave będą używać programu ustawionego na lampie Master co pozwala zaoszczędzić czas i wysiłek przy ustawianiu wielu lamp.

Wartość domyślna to „Standard” co oznacza że lampa operuje samodzielnie.

Kiedy RSX jest ustawiony jako jednostka Master, będzie musiała mieć nadany kanał od 01 do 10. Wszystkie jednostki Slave będą musiały zostać podłączone pod ten sam kanał.

W przypadku gdzie jest wiele grup Master/Slave na niewielkiej przestrzeni, jednostki Master muszą mieć nadane różne kanały by uniknąć zakłóceń.

- Obróć pokrętkę nastawne i wybierz „Standard”.
- Naciśnij pokrętkę nastawne by wejść w stronę ustawień.

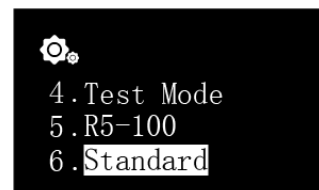

- Po wybraniu jednostki Master/Slave, naciśnij pokrętkę nastawne by nadać jej kanał.
- Po wybraniu jednostki Master/Slave, naciśnij pokrętkę nastawne by nadać jej kanał.
- Naciśnij i przytrzymaj pokrętkę nastawne przez 3 sekundy by zapisać ustawienia.



7. Exit

- Naciśnij „Exit” by uruchomić ponownie lampę.

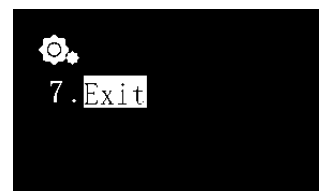

Konserwacja lampy

Użytkownik musi przeprowadzać następujące okresowe czynności konserwacyjne:

- Używając wilgotnej ściereczki wyczyścić akrylowe soczewki by upewnić się że nie są pokryte solą bądź innymi zanieczyszczeniami. Brudne soczewki zmniejszają drastycznie zdolność oświetleniową lampy, a więc by utrzymać lampę w najlepszej kondycji należy raz w tygodniu wyczyścić soczewki.
- Usunąć kurz i brud zalegający w wiatraczkach. Regularnie i dokładnie czyszczone wiatraki działają dłużej niż te które nie są. Wiatraki to części zużywalne i muszą być wymieniane co 24-36 miesięcy zależnie od częstotliwości czynności konserwacyjnych wykonywanych na nich.
- Wyczyścić / Usunąć sól lub kurz i brud z aluminiowej obudowy lampy gdyż mogą one wpływać na sprawność chłodzenia lampy.

Uwaga: Nie wykonywanie powyższych czynności konserwacyjnych może spowodować niepotrzebne uszkodzenia lampy lub przepadnięcie gwarancji!

Uwaga:

Prosimy odwiedzać stronę www.maxspect.com w celu zapoznania się z ewentualnymi aktualizacjami konfiguracji dido Led, kolorow widma, itp



Ledowe systemy oświetleniowe Maxspect™ RSX pokryte są 12 miesięczną gwarancją, która obejmuje wady produkcji.

Jeżeli wada produkcji pojawi się w okresie gwarancji, Maxspect Ltd. zastrzega sobie prawo naprawy (przy użyciu zarówno części nowych jak i regenerowanych) bądź wymiany (na produkt nowy bądź regenerowany) produktu wadliwego, bez dodatkowych kosztów.

Gwarancja nie obejmuje urządzeń uszkodzonych na skutek niewłaściwego użytkowania, modyfikacji, upadków, nie autoryzowanych prób naprawy.

WYŁĄCZENIE ZA SZKODY WTÓRNE I PRZYPADKOWE:

Użytkownik urządzeń Maxspect nie ma prawa roszczyć żądań odszkodowania za szkody pośrednie i bezpośrednie, bez jakichkolwiek ograniczeń, wynikające z: osobistych niedogodności, uszkodzenia mienia osobistego, urządzeń telefonicznych, strat materialnych, itp. Niniejsza gwarancja obejmuje określone prawa konsumenta.

MAXSPECT LTD. NIE GWARANTUJE, A JEDNOCZESNIE NIE DEKLARUJE, POŚREDNIO I BEZPOSREDNIO, W ODNIESIENIU DO JAKOŚCI PRODUKTÓW: WYDAJNOŚCI PRODUKTU, PRZYDATNOŚCI DO CELÓW INNYCH NIŻ WSKAZANY. W REZULTACIE PRODUKT TEN, SPRZEDAWANY W OBECNEJ POSTACI, PODDANY JEST CAŁKOWITEMU RYZYKU NABYWCY ZWIĄZANEMU Z JEGO JAKOŚCIĄ I WYDAJNOŚCIĄ.

W ŻADNYM WYPADKU MAXSPECT LTD. NIE MOŻE ZOSTAĆ POCIĄGNIĘTY DO ODPOWIEDZIALNOŚCI ZA SZKODY POŚREDNIE I BEZPOŚREDNIE, SPECYFICZNE I WYPADKOWE, WYNIKAJĄCE Z JAKIEGOKOLWIEK PROBLEMU ZWIĄZANEGO Z PRODUKTEM BĄDŹ JEGO DOKUMENTACJĄ.

Gwarancja oraz wyżej wymienione zasady zastępują wszelkie inne, wyrażone ustnie i pisemnie, wyraźnie bądź w sposób domniemany. W żadnym wypadku sprzedawca, agent, pracownik, itp, nie jest uprawniony do naniesienia jakichkolwiek poprawek, modyfikacji, poszerzeń i dodatków do niniejszej gwarancji.

Nie wszystkie kraje przewidują wyłączenie bądź ograniczenie odpowiedzialności za szkody wypadkowe i wtórne, w związku z czym niniejsze zasady gwarancji mogą nie mieć zastosowania w Państwa wypadku.

fabryczne ustawienia

Preset 1

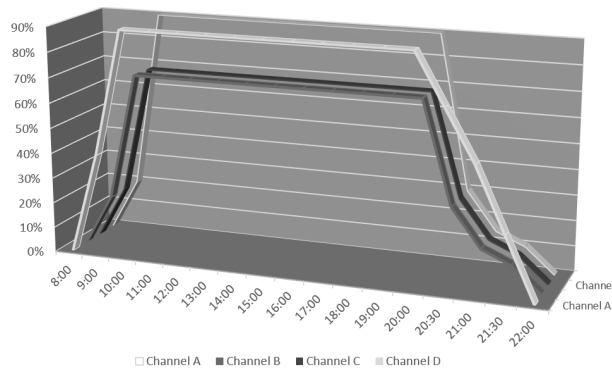

Preset 2

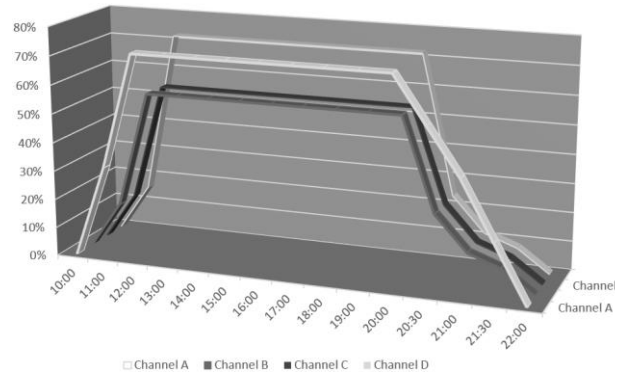

Preset 3

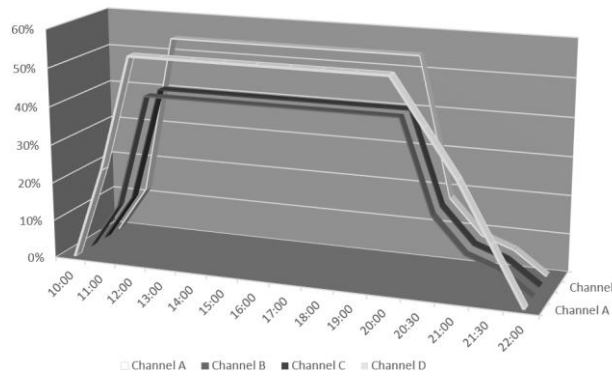

Preset 4

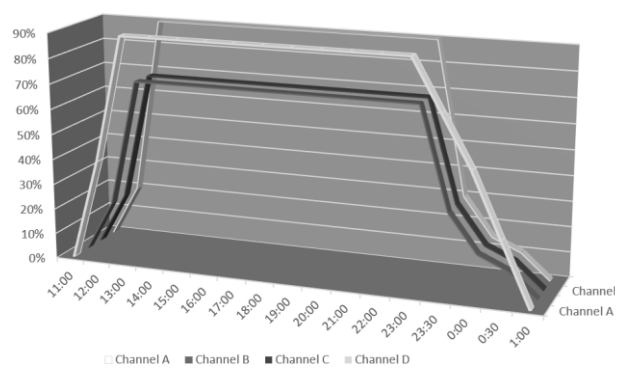

Polski

亲爱的客户,

感谢您选购我司商品。

为确保您的安全及使用本产品时得到最佳的效果，请仔细阅读此使用手册。

用户资料：

购买日期：

经销商名称：

经销商地址：

经销商网页：

经销商电邮：

经销商电话：

请检查包装内物件是否齐全。

R5-100

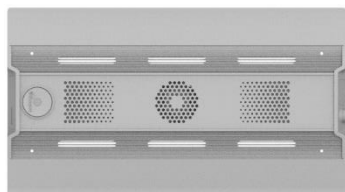

R5-150

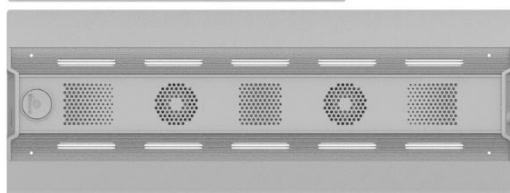

R5-200

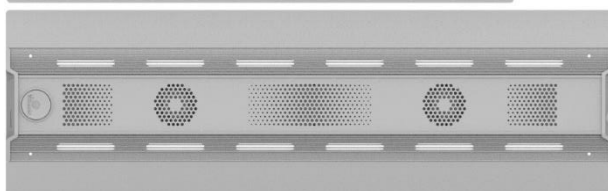

R5-300

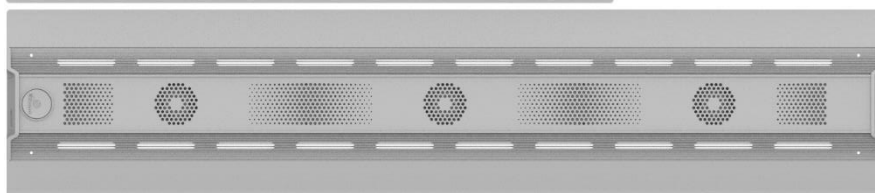

电源

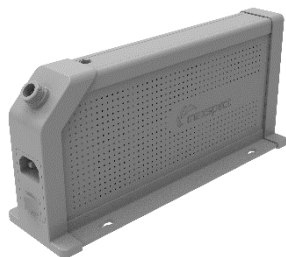

电源线



PVC 贴

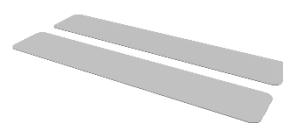

支架



手拧螺丝

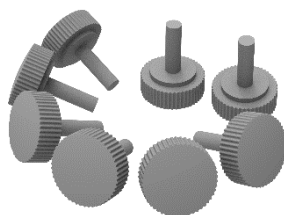

螺丝

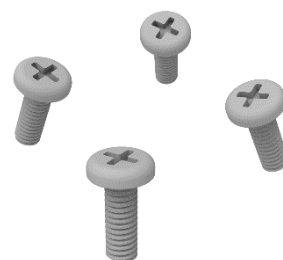

请在操作前，仔细阅读本操作说明，并特别注意遵照下列安全建议。

请保留本说明书以便日後查阅。

安装及使用 Maxspect™ RSX LED 灯具前，请注意：

1. 移除灯具外包装袋及灯具上的保护膜。
2. 开启灯具时请切勿用肉眼直视灯珠，否则可能会对眼睛造成伤害。

安全提示：

1. **电源** — 禁止破坏两极插头或接地型插头的安全用途。两极插头有两个接触片，其中一个比较宽。接地型插头有两个接触片和一个接地插脚。两极插头的较宽接触片或接地型插头的接地插脚能够确保使用者的安全。如果提供的插头与您的插座不匹配，请联系电工更换插座。
2. **电源线保护** — 布置电源线时，确保电源线不被踩踏、挤压或阻挡。手湿时，切勿触碰插头或电源线。插入或拔出电源插头时，应始终紧握插头。
3. **安装** — 本设备只能安装于室内，并且使用由生产厂家提供及指定的附件，安装架与悬挂套件。

操作提示：

1. 使用本设备时应始终遵照使用手册的操作说明。
2. 本设备的安装位置应远离热源，例如暖炉，也不能暴露于过度高温的环境，如阳光、火源之类。
3. 为降低火灾或雷击的危险，切勿把本设备暴露于淋雨、潮湿、滴水或溅水的环境中。
4. 本设备应安装或放置在不影响正常通风的位置上使用。
5. 本设备应远离产生强磁场的设备或装置。
6. 本设备只能使用干布清洁。

安装 RSX LED 灯具

将灯具接通电源前，请使用所提供的支架将灯具安装妥当。

1. 支架安装

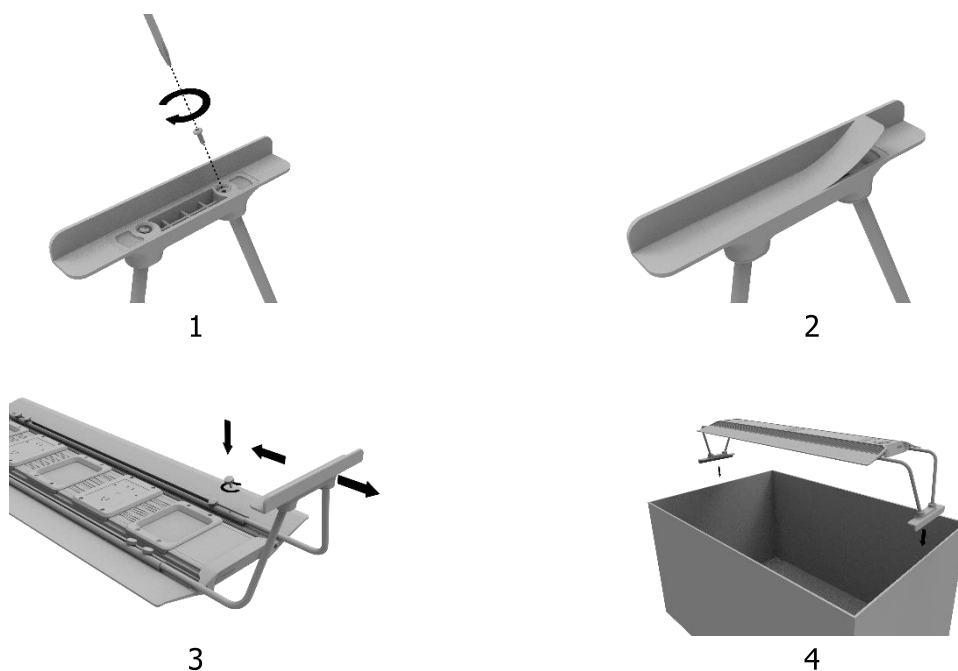

2. 吊装 (吊装组件须另购)

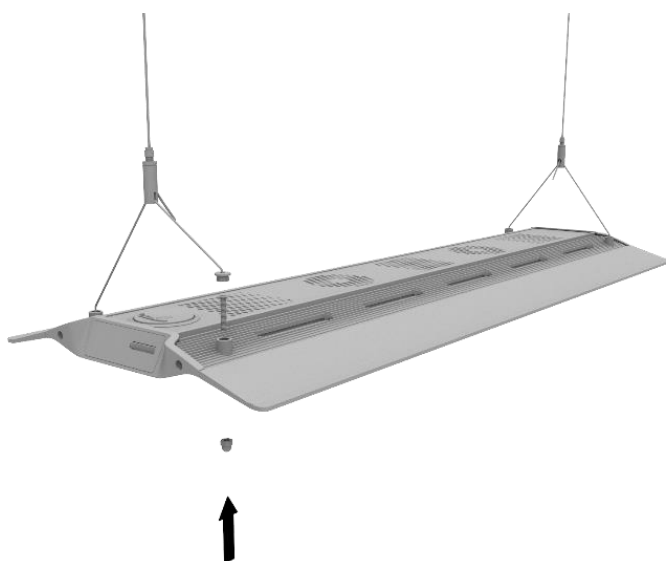

集成控制器

灯具内置集成控制器。集成控制器由一块 OLED 屏幕和一个旋钮组成，用户可通过它控制灯具的所有功能。



独立、主/从灯模式

假设有两台或以上的灯具，用户可通过主/从灯模式连接所有灯具，所有从灯会同步运行主灯设定的功能，节省用户设置多台灯具的时间。

苹果或安卓移动设备

当使用 ICV6 (需另购) 无线连接灯具时，用户可利用苹果或安卓移动设备通过 Syna-G 系统控制灯具。



基本操作

请依照以下操作说明控制 RSX LED 灯具。

当灯具接通电源后，将自动运行对上一次灯具断电前的模式，包括所设置的时间，定义的程序，亮度值等。

温控散热风扇

灯具内置温控散热系统。当灯体温度超过 55°C/131°F 时散热风扇开始运转，低于 45°C/113°F 时停止工作。

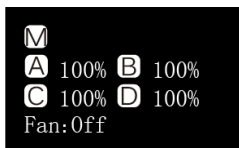

低于 45°C/113°F

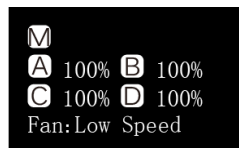

高于 55°C/131°F

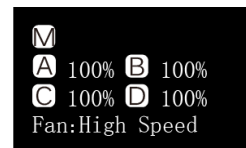

高于 65°C/149°F

当散热风扇失效时，灯具可能会由于过热（超过 80°C/176°F）而进入故障保护状态，此时所有 LED 灯组会立刻关闭。而当灯体温度低于 70°C/158°F 时，灯具会自动退出故障保护状态，同时所有 LED 灯组恢复运作。

切换自动与手动操作模式

灯具内置两种操作模式：自动和手动操作模式。用户可通过灯具上的旋钮在两种模式之间来回切换。

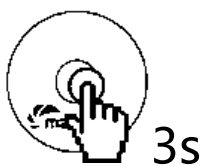

- 在自动或手动模式主界面按住旋钮 3 秒可切换至另一个操作模式。

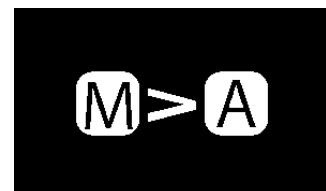

手动操作模式

- 按动旋钮进入设置界面。
- 再次按动旋钮在 LED 灯组通道间切换。
- 转动旋钮设置 LED 灯组亮度。
- 按住旋钮 3 秒保存设定和退出设置界面。

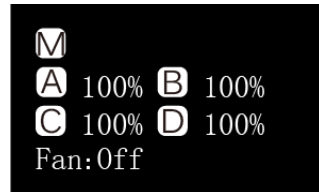

自动操作模式

- 按动旋钮进入设置界面。
- 转动旋钮切换选项。
- 按住旋钮 3 秒保存设定并退出设置界面。

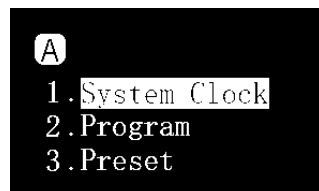
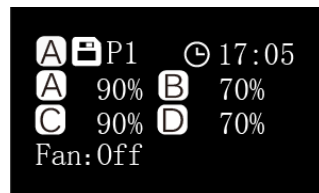

自动操作模式内有三个选项供用户设定：

系统时钟：将系统时间设定为用户当地时间。

光照周期：用于设定每个 LED 灯组在一天当中不同时间点的亮度值。

预设选项：内置 4 组预设选项供用户选择。(请参考 112 页)

预设 1：针对硬骨珊瑚为主的鱼缸。

预设 2：针对硬骨珊瑚和软骨珊瑚混合的鱼缸。

预设 3：针对软骨珊瑚和软体生物混合的鱼缸。

预设 4：针对硬骨珊瑚为主的鱼缸，但提供不同的日出和日落时间点，并带有夜光效果的设定。

设置系统时钟

- 按动旋钮进入设置界面，然后选择"System Clock"。
- 再次按动旋钮在小时与分钟间切换。
- 转动旋钮设置时间。
- 按住旋钮 3 秒保存设定并退出设置界面。

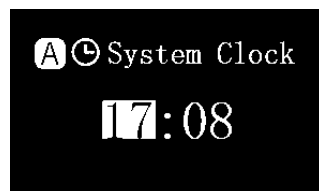
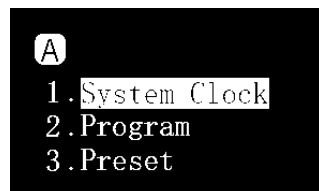

认识时间点

系统可设置最多 24 个时间点。用户可通过打开或关闭每个时间点，为每个时间点设置时间值，并为每个 LED 灯组设置特定的亮度，以达到控制系统的光照亮度和光照周期。

以预设 1 为例，它是一组针对以硬骨珊瑚为主的设定。它的光照周期从 08:00 点开始，LED 灯组开始逐渐变亮，在 10:00 点达到最大亮度并一直维持到 20:00 点，然后 LED 灯组亮度开始下降，直到 22:00 点 LED 灯组转换到夜光效果。

	TP01	TP02	TP03	TP04	TP05	TP06	TP07	TP08
	08:00	09:00	10:00	20:00	20:30	21:00	21:30	22:00
通道 A	0%	40%	90%	90%	70%	50%	25%	0%
通道 B	0%	20%	70%	70%	30%	15%	10%	0%
通道 C	1%	20%	70%	70%	30%	15%	10%	1%
通道 D	0%	20%	90%	90%	30%	15%	10%	0%

下图显示出 6 个 LED 灯组在预设 1 设定下的运行情况。

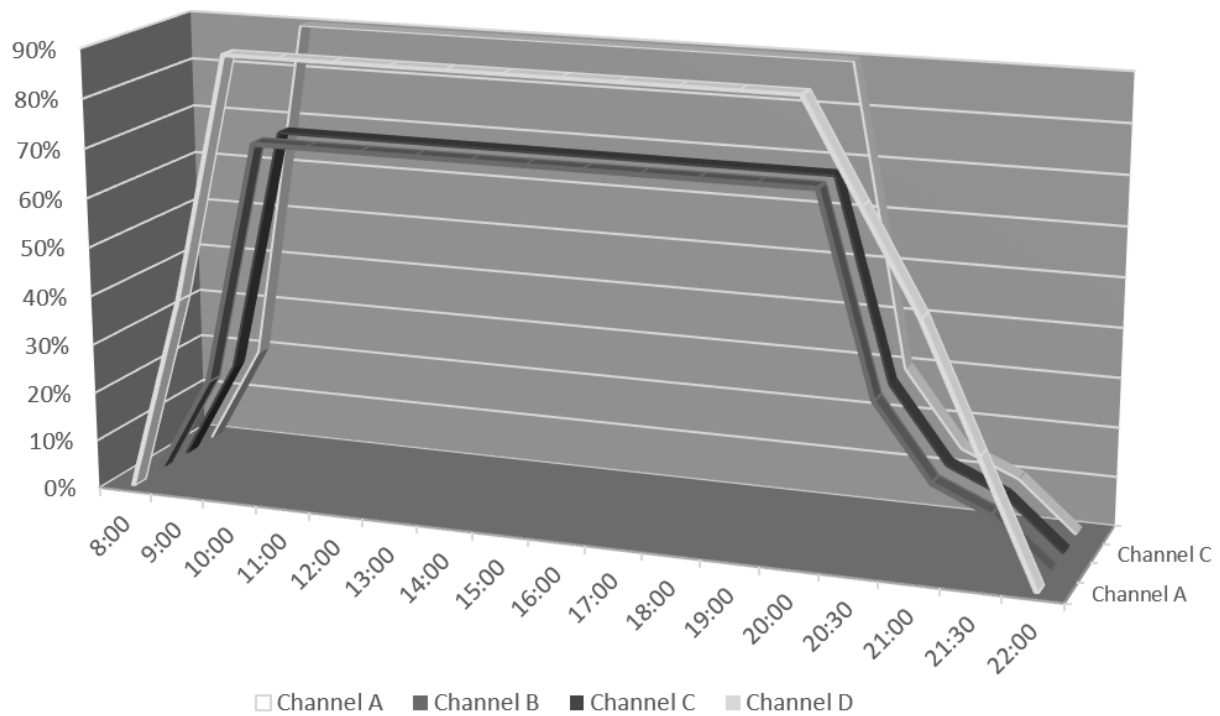

设置光照周期

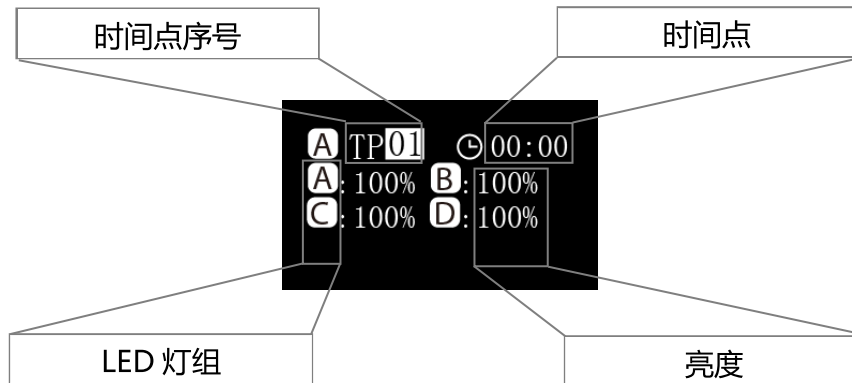

设置

- 按动旋钮在选项之间来回切换。
- 转动旋钮设置参数。
- 按住旋钮 3 秒切换至下一页。

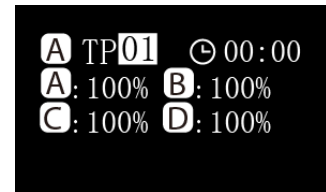

保存

- 转动旋钮选择"Apply"。
- 按动旋钮保存设置。
- 按住旋钮 3 秒返回主界面。



预览

- 转动旋钮选择"Preview"。
- 按动旋钮开始快速预览功能，整个过程历时 3 分钟。
- 按住旋钮 3 秒返回主界面。



修改

- 转动旋钮选择"Modify"。
- 按动旋钮重新设置参数，具体操作参考“设置”。



选择预设选项

- 转动旋钮在预设选项之间来回切换。
- 按动旋钮切换至下一页。

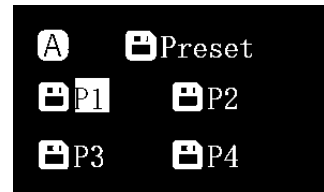

保存

- 转动旋钮选择"Apply".
- 按动旋钮保存设置。



预览

- 转动旋钮选择"Preview".
- 按动旋钮开始快速预览功能，整个预览历时 3 分钟。
- 按住旋钮 3 秒返回主界面。

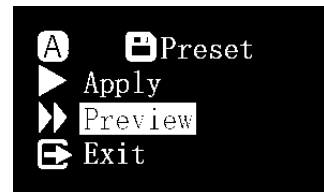

退出

- 转动旋钮选择"Exit".
- 按动旋钮返回主界面。



系统设定

系统设定包含一组基础功能供用户维护灯具使用。

要进入系统设定界面，首先断开灯具电源，按住旋钮，然后接通灯具电源，直到屏幕显示系统设定界面便可松开旋钮。

系统设定包含 7 项功能：

1. 固件更新
2. 固件恢复
3. 恢复出厂设置
4. 系统测试
5. 型号选择
6. 独立、主/从灯模式
7. 退出

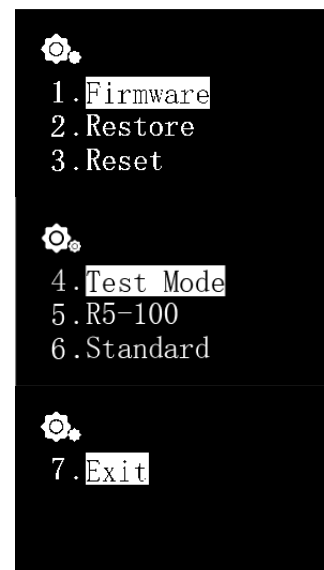

1. 固件更新

此功能用于更新系统固件。

- 转动旋钮选择"Firmware".
- 按动旋钮开始更新固件。
- 当系统检测不到 TF(micro SD) card 或正确的固件文件时，屏幕会相应提示"NO TF Card"或"Wrong File".
- 正常更新时屏幕会显示更新进度。
- 当固件成功更新后，系统会自动重启，新固件版本号会显示在启动界面中；更新固件不会影响用户设定。

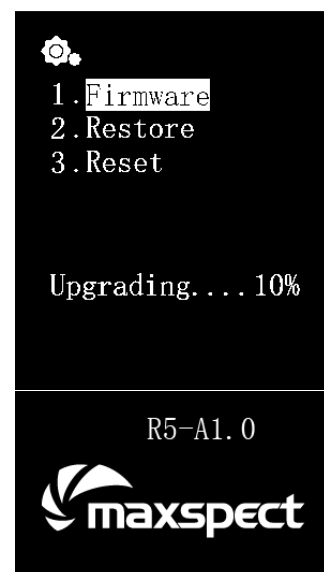

2. 固件恢复

此功能用于恢复出厂固件。当成功恢复后，系统会自动重启，版本号会显示在启动界面中，恢复出厂固件不会影响用户设定。

- 转动旋钮选择"Restore"。
- 按动旋钮开始恢复固件。



3. 恢复出厂设置

此功能用于恢复出厂设置。成功恢复后，系统会自动重启。

- 转动旋钮选择"Reset"。
- 按动旋钮开始恢复出厂设定。



4. 系统测试

此功能用于系统检测。**用户应在经销商或售后服务人员的指导或授意下执行系统检测操作。**

5. 型号选择

此功能用于设置灯具型号，并且当灯具和 Syna-G 系统连接时，作为灯具名称使用。**正常情况下，用户不应更改此项设定。**

6. 独立、主/从模式

此功能可用于设置灯具为独立工作模式，或当用户拥有多台灯具时，设置为主/从工作模式来让它们同步运作。

连接后，所有从灯会同步运行主灯的设置，以节省用户设置多台灯具的时间。

默认选项"Standard"表示灯具工作在独立运作模式。

当灯具设定为主灯时，需要在 01 至 10 间选择一个通道，并且从灯也需要设置为相同的通道。

如果在近距离内有多个主/从灯组，不同主/从灯组必须分配不同通道以避免相互干扰。

- 转动旋钮选择"Standard"。
- 按动旋钮进入设置界面。
- 转动旋钮选择主/从模式。
- 然后按动旋钮进入通道选择选项，转动旋钮选择通道。
- 按住旋钮 3 秒保存设定。

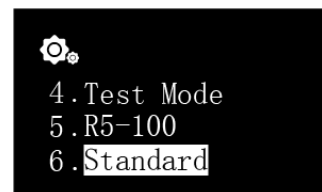

7. 退出

- 转动旋钮选择"Exit"。
- 按动旋钮重启灯具。

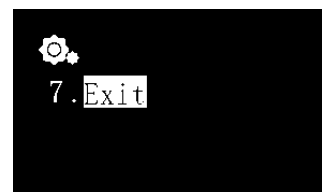

灯具维护

用户必须定期维护灯具，内容包括但不限于以下步骤：

- 为保持灯具的最佳性能，用户每星期应最少对灯具清洁一次，用微湿的抹布清除亚克力透镜上的盐巴或污垢，否则可能会严重影响灯光的输出。
- 定期及适当地清洁散热风尚可显著延长其使用寿命。散热风扇属于损耗品，依照对其维护的频率而定，用户应该在 24-36 个月内更换新的散热风扇。
- 用户应定期清除铝合金灯体上的盐巴或污垢，否则可能会影响灯体的散热性能。

提示：如不依照以上的方法对产品进行定期的维护以至造成不必要的损坏可能会丧失产品的保修。

提示：

关于产品规格等详细信息，请浏览 Maxspect 官方网站：www.maxspect.com



所有迈光品牌 (Maxspect) RSX LED 照明系统产品自购买之日起 12 个月内若有质量问题，可享有 Maxspect 公司的保修服务。若在保修期内出现质量问题，Maxspect 公司将免费维修或更换配件。

若产品由于误用，被改装，发生事故，处理不当，或使用不当而受到损坏，或未经授权自行维修的，则不在保修范围之内。不在保修范围的情况包括但不限于，使用改装灯泡和修改电路等被视为误用或滥用而损坏产品的行为。

间接及附带损害免责声明:

Maxspect 对您或其他使用者的间接或附带损害不承担责任。间接或附带损害包括但不限于，使用产品造成的损失或不便，对个人财产造成的损失，如电话，收入损失或盈利损失。本质保书赋予您合法权利，在不同的地区您还可能享有其它权利。

除上面明确提出的内容外，Maxspect 公司对产品的质量，性能，适销性或特别用途的适用性均没有作出明示或暗示的担保或陈述。因此，本产品“按现状”提供，您作为购买者承担有关此产品的质量和性能的全部风险。

在任何情况下，Maxspect 公司均不对因本产品或其文件的缺陷而引起的直接的、间接的、特别的、附带的或结果性的损害承担责任。

上述质保书，声明和故障排除方法是唯一版本，没有其它口头的或书面的，明示的或暗示的内容。在任何时候，Maxspect 公司的经销商，代理商或雇员都无权对此质保书进行更改、扩展或补充。

由于某些地区不允许此类附带性或结果性损害的免责或有限责任，上述限制可能不适用于您。

预设 1

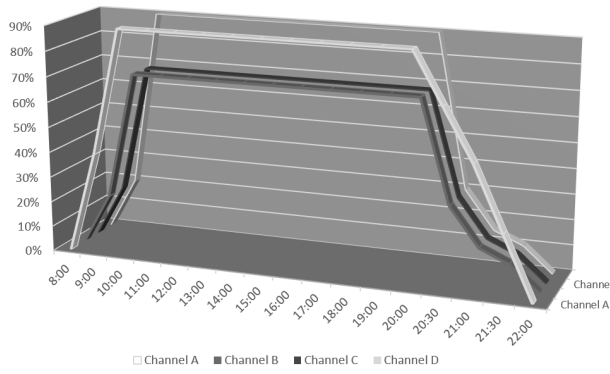

预设 2

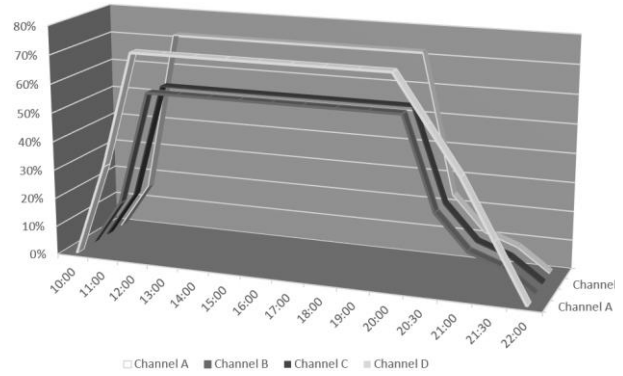

预设 3

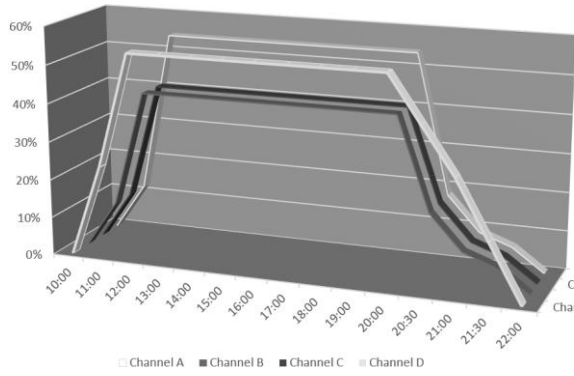

预设 4

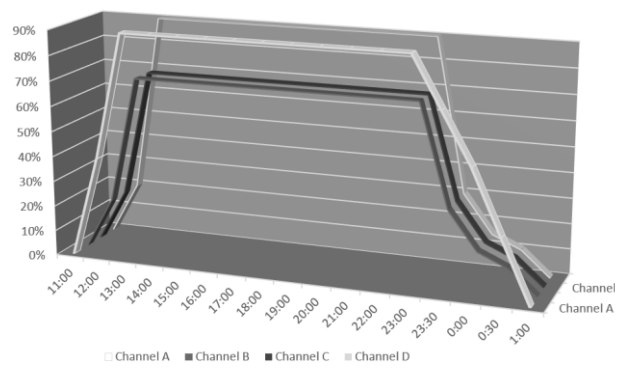

親愛的客戶,

多謝您選購我司商品。

為確保您的安全及使用本產品時得到最佳的效果，請詳細閱讀此使用說明書。

用戶資料：

購買日期：

經銷商名稱：

經銷商地址：

經銷商網頁：

經銷商電郵：

經銷商電話：



<https://www.facebook.com/Maxspect>



<http://twitter.com/maxspectled>

請檢查包裝內物件是否齊全。

R5-100

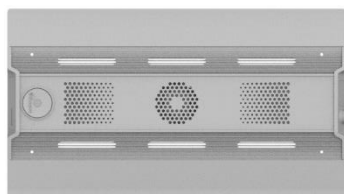

R5-150

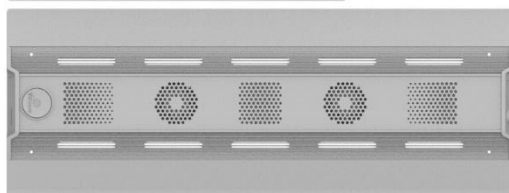

R5-200

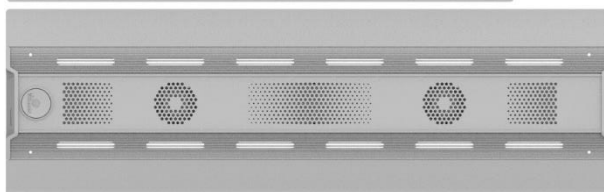

R5-300

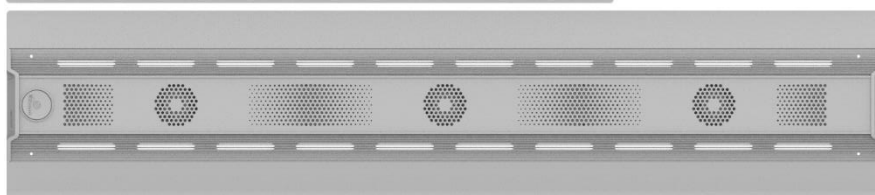

電源

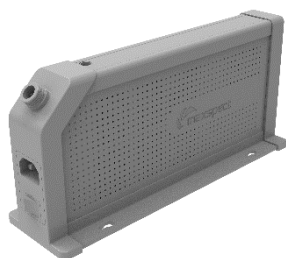

電源線



PVC 貼

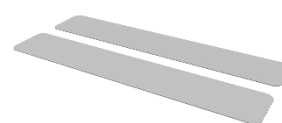

支架



手擰螺絲

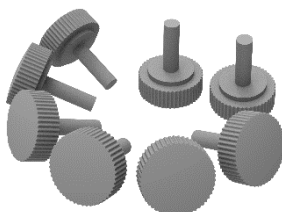

螺絲

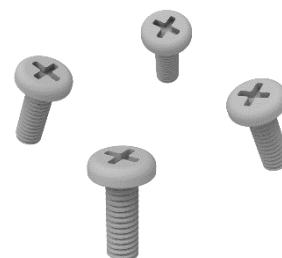

請在操作前，仔細閱讀本操作說明，並特別注意遵照下列安全建議。

請保留本說明書以便日後查閱。

安裝及使用 Maxspect™ RSX LED 燈具前，請注意：

1. 移除燈具外包裝袋及燈具上的保護膜。
2. 開啟燈具時請切勿用肉眼直視燈珠，否則可能會對眼睛造成傷害。

安全提示

1. **電源** — 禁止破壞兩極插頭或接地型插頭的安全用途。兩極插頭有兩個接觸片，其中一個比較寬。接地型插頭有兩個接觸片和一個接地插腳。兩極插頭的較寬接觸片或接地型插頭的接地插腳能夠確保使用者的安全。如果提供的插頭與您的插座不匹配，請聯系電工更換插座。
2. **電源線保護** — 布置電源線時，確保電源線不被踩踏、擠壓或阻擋。手濕時，切勿觸碰插頭或電源線。插入或拔出電源插頭時，應始終緊握插頭。
3. **安裝** — 本設備只能安裝於室內，並且使用由生產廠家提供及指定的附件，安裝架與懸掛套件。

操作提示

1. 使用本設備時應始終遵照使用手冊的操作說明。
2. 本設備的安裝位置應遠離熱源，例如暖爐，也不能暴露於過度高溫的環境，如陽光、火源之類。
3. 為降低火災或雷擊的危險，切勿把本設備暴露於淋雨、潮濕、滴水或濺水的環境中。
4. 本設備應安裝或放置在不影響正常通風的位置上使用。
5. 本設備應遠離產生強磁場的設備或裝置。
6. 本設備只能使用乾布清潔。

安裝 RSX LED 燈具

將燈具接通電源前，請使用所提供的支架將燈具安裝妥當。

1. 支架安裝

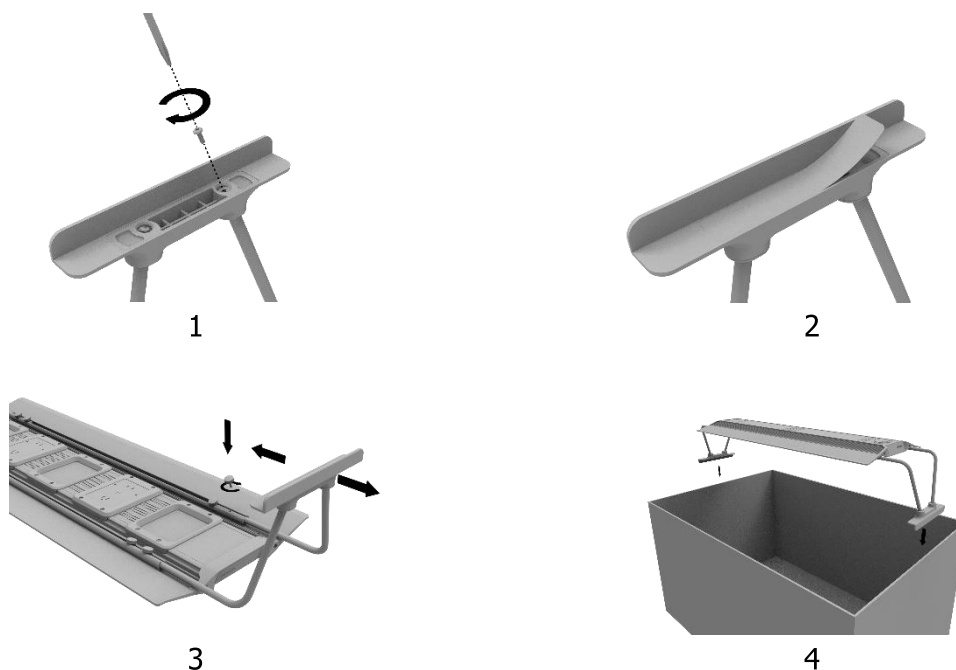

2. 吊裝 (吊裝組件須另購)

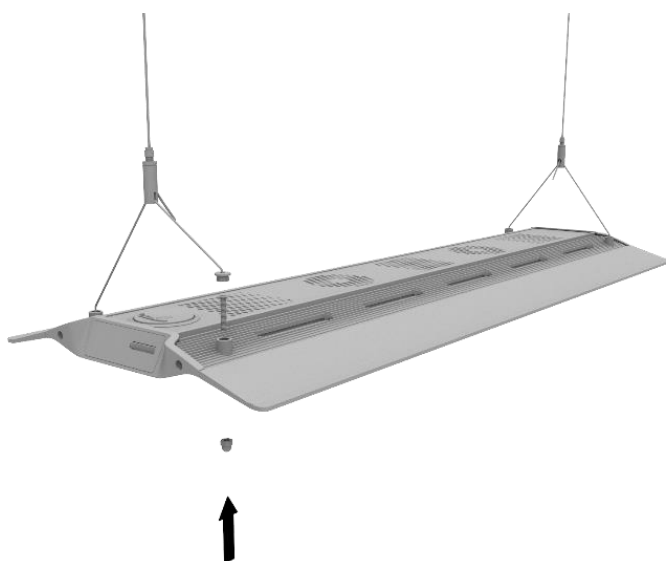

集成控制器

燈具內置集成控制器。集成控制器由一塊 OLED 屏幕和一個旋鈕組成，用戶可通過它控制燈具的所有功能。



獨立、主/從燈模式

假設有兩台或以上的燈具，用戶可通過主/從燈模式連接所有燈具，所有從燈會同步運行主燈設定的功能，節省用戶設置多臺燈具的時間。

蘋果或安卓移動設備

當使用 ICV6 (需另購) 無線連接燈具時，用戶可利用蘋果或安卓移動設備通過 Syna-G 系統控制燈具。

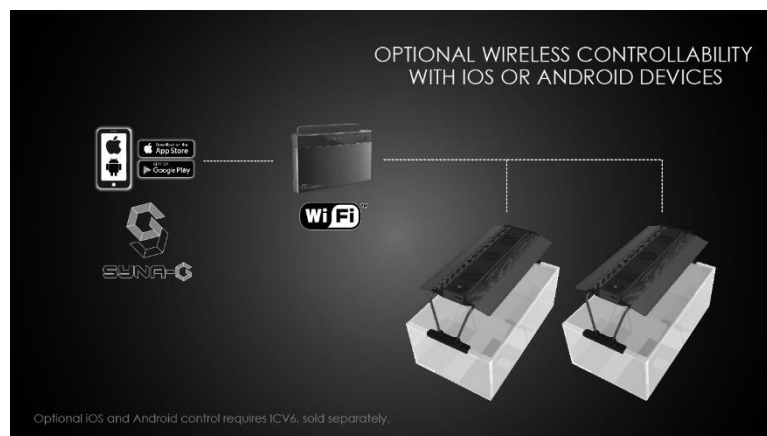

基本操作

請依照以下操作說明控制 RSX LED 灯具。

當燈具接通電源後，將自動運行上一次燈具斷電前的模式，包括所設置的時間，定義的程序，亮度值等。

溫控散熱風扇

燈具內置溫控散熱系統。當燈體溫度超過 55°C/131°F 時散熱風扇開始運轉，低於 45°C/113°F 時停止工作。

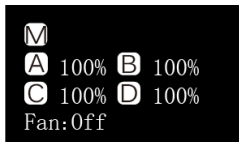

低於 45°C/113°F

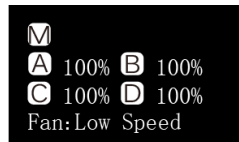

高於 55°C/131°F

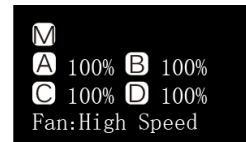

高於 65°C/149°F

當散熱風扇失效時，燈具可能會由於過熱（超過 80°C/176°F）而進入故障保護狀態，此時所有 LED 燈組會立即關閉。而當燈體溫度低於 70°C/158°F 時，燈具會自動退出故障保護狀態，同時所有 LED 燈組恢復運作。

切換自動與手動操作模式

燈具內置兩種操作模式：自動和手動操作模式。用戶可通過燈具上的旋鈕在兩種模式間來回切換。



- 在自動或手動模式主界面按住旋鈕 3 秒切換至另一操作模式。

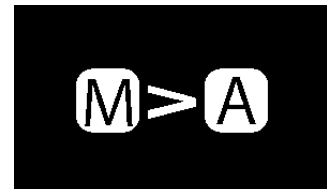

手動操作模式

- 按動旋鈕進入設置界面。
- 再次按動旋鈕在 LED 燈組通道間切換。
- 轉動旋鈕設置 LED 燈組亮度。
- 按住旋鈕 3 秒保存設定和退出設置界面。

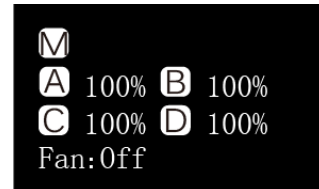

自動操作模式

- 按動旋鈕進入設置界面。
- 轉動旋鈕切換選項。
- 按住旋鈕 3 秒保存設定並退出設置界面。

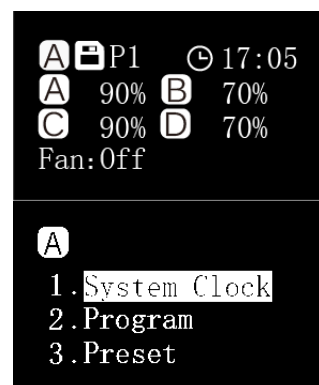

自動操作模式內有三個選項供用戶設定：

系統時鐘：將系統時間設定為用戶當地時間。

光照週期：用於設定每個 LED 燈組在一天當中不同時間點的亮度值。

預設選項：內置 4 組預設選項供用戶選擇。(參考 128 頁)

預設 1：針對硬骨珊瑚為主的魚缸。

預設 2：針對硬骨珊瑚和軟骨珊瑚混合的魚缸。

預設 3：針對軟骨珊瑚和軟體生物混合的魚缸。

預設 4：針對硬骨珊瑚為主的魚缸，但提供不同的日出和日落時間點，並帶有夜光效果的設定。

設置系統時鐘

- 按動旋鈕進入設置界面，然後選擇 “System Clock”。
- 再次按動旋鈕在小時與分鐘間切換。
- 轉動旋鈕設置時間。
- 按住旋鈕 3 秒保存設定並退出設置界面。

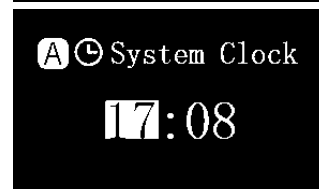
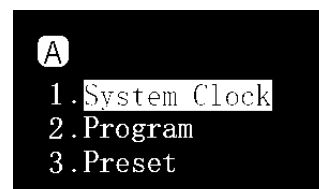

認識時間點

系統可設置最多 24 個時間點。用戶可通過打開或關閉每個時間點，為每個時間點設置時間值，並為每個 LED 燈組設置特定的亮度，以達到控制系統的光照亮度和光照週期。

以預設 1 為例，它是一組針對以硬骨珊瑚為主的設定。它的光照週期從 08:00 點開始，LED 燈組開始逐漸變亮，在 10:00 點達到最大亮度並一直維持到 20:00 點，然後 LED 燈組亮度開始下降，直到 22:00 點 LED 燈組轉換到夜光效果。

	TP01	TP02	TP03	TP04	TP05	TP06	TP07	TP08
	08:00	09:00	10:00	20:00	20:30	21:00	21:30	22:00
通道 A	0%	40%	90%	90%	70%	50%	25%	0%
通道 B	0%	20%	70%	70%	30%	15%	10%	0%
通道 C	1%	20%	70%	70%	30%	15%	10%	1%
通道 D	0%	20%	90%	90%	30%	15%	10%	0%

下圖顯示 6 個 LED 燈組在預設 1 設定下的運行情況。

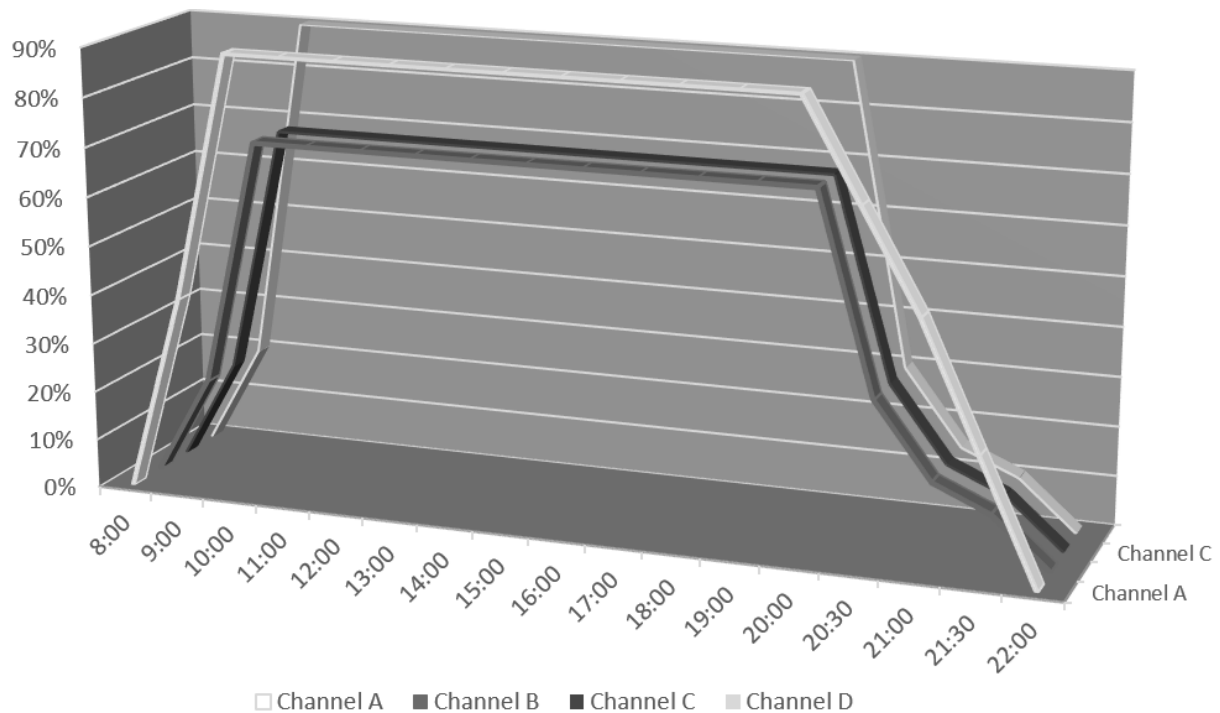

設置光照週期

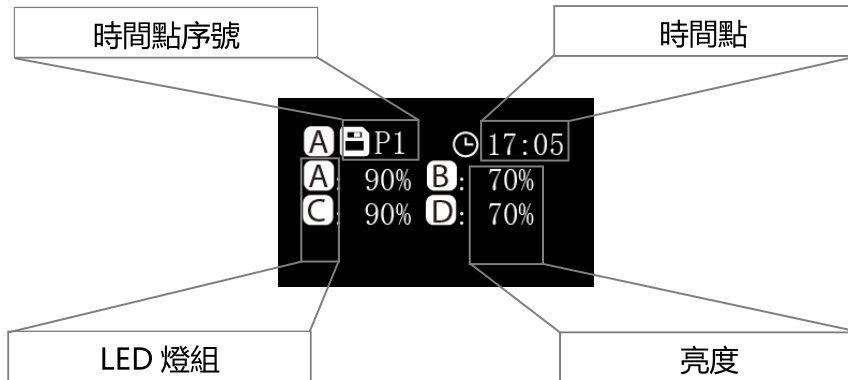

設置

- 按動旋鈕在選項之間來回切換。
- 轉動旋鈕設置參數。
- 按住旋鈕 3 秒切換至下一頁面。

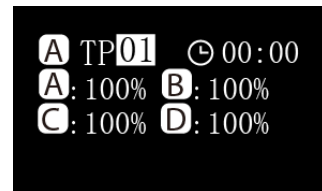

保存

- 轉動旋鈕選擇 "Apply" 。
- 按動旋鈕保存設置。
- 按住旋鈕 3 秒返回主界面。



預覽

- 轉動旋鈕選擇 "Preview" 。
- 按動旋鈕開始快速預覽功能，整個過程歷時 3 分鐘。
- 按住旋鈕 3 秒返回主界面。



修改

- 轉動旋鈕選擇 "Modify" 。
- 按動旋鈕重新設置選項，具體操作參考 "設置"。



選擇預設選項

- 轉動旋鈕在預設選項之間來回切換。
- 按動旋鈕切換至下一頁面。

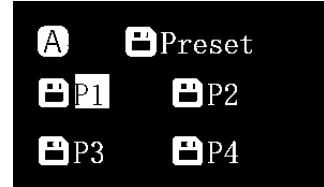

保存

- 轉動旋鈕選擇 “Apply” 。
- 按動旋鈕保存設置。



預覽

- 轉動旋鈕選擇 “Preview” 。
- 按動旋鈕開始快速預覽功能，整個過程歷時 3 分鐘。
- 按住旋鈕 3 秒返回主界面。



退出

- 轉動旋鈕選擇 “Exit” 。
- 按動旋鈕返回主界面。



系統設定

系統設定包含一組基礎功能供用戶維護燈具使用。

要進入系統設定界面，首先斷開燈具電源，按住旋鈕，然後接通燈具電源，直到屏幕顯示系統設定界面便可鬆開旋鈕。

系統設定包含 7 項功能：

1. 固件更新
2. 固件恢復
3. 恢復出廠設置
4. 系統測試
5. 型號選擇
6. 獨立、主/從模式
7. 退出

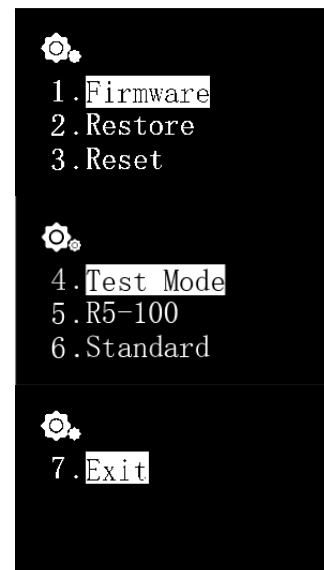

1. 固件更新

此功能用於更新系統固件。

- 轉動旋鈕選擇 “Firmware” 。
- 按動旋鈕開始更新固件。
- 當系統檢測不到 TF(micro SD) Card 或正確的固件文件時，屏幕會相應提示 “NO TF Card” 或 “Wrong File” 。
- 正常更新時屏幕會顯示更新進度。
- 當固件成功更新後，系統會自動重啟，新固件版本號會顯示在啟動界面中，更新固件不會影響用戶設定。

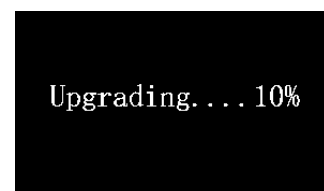

2. 固件恢復

此功能用於恢復出廠固件。當成功恢復後，系統會自動重啟，版本號會顯示在啟動界面中，恢復出廠固件不會影響用戶設定。

- 轉動旋鈕選擇“Restore”。
- 按動旋鈕開始恢復固件。



3. 恢復出廠設置

此功能用於恢復出廠設置。成功恢復後，系統會自動重啟。

- 轉動旋鈕選擇“Reset”。
- 按動旋鈕開始恢復出廠設定。



4. 系統測試

此功能用於系統檢測。**用戶應在經銷商或售後服務人員的指導或授意下執行系統檢測操作。**

5. 型號選擇

此功能用於設置燈具型號，並且當燈具和 Syna-G 系統連接時，作為燈具名稱使用。**正常情況下，用戶不應更改此項設定。**

6. 獨立、主/從模式

此功能可用於設置燈具為獨立工作模式，或當用戶擁有多臺燈具時，設置為主/從工作模式來讓它們同步運作。

連接後，所有從燈會同步運行主燈的設定，以節省用戶設置多臺燈具的時間。

默認選項“Standard”表示燈具工作在獨立運作模式。

當燈具設定為主燈時，需要在 01 至 10 間選擇一個通道，並且從燈也需要設置為相同的通道。

如果在近距離內有多個主/從燈組，不同主/從燈組必須分配不同通道以避免相互干擾。

- 轉動旋鈕選擇"Standard"。
- 按動旋鈕進入設置界面。
- 轉動旋鈕選擇主/從模式。
- 然後按動旋鈕進入通道選擇選項，轉動旋鈕選擇通道。
- 按住旋鈕 3 秒保存設定。

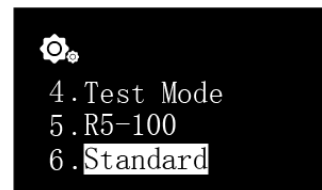

7. 退出

- 轉動旋鈕選擇"Exit"。
- 按動旋鈕重啟燈具。

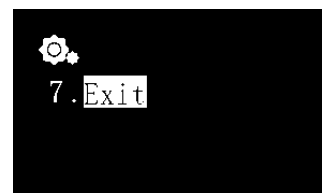

燈具維護

用戶必須定期維護燈具，內容包括但不限於以下步驟：

- 為保持燈具的最佳性能，用戶每星期應最少對燈具清潔一次，用微濕的抹布清除亞克力透鏡上的鹽巴或污垢，否則可能會嚴重影響燈光的輸出。
- 定期及適當地清潔散熱風扇可顯著延長其使用壽命。散熱風扇屬於損耗品，依據對其維護的頻率而定，用戶應該在 24-36 個月內更換新的散熱風扇。
- 用戶應定期清除鋁合金燈體上的鹽巴或污垢，否則可能會影響燈體的散熱性能。

提示：如不依照以上的方法對產品進行定期的維護以至造成不必要的損壞可能會喪失產品的保修。

提示：

有關產品規格等詳細信息，請瀏覽 Maxspect 官方網站：www.maxspect.com



所有邁光品牌(Maxspect)的 RSX LED 照明系統產品自購買之日起 12 個月內若有質量問題，可享有 Maxspect 公司的保修服務。若在保修其內出現質量問題，Maxspect 公司將免費維修或更換配件。

若產品由於誤用，被改裝，發生事故，處理不當，或使用不當而受到損壞，或未經授權自行維修的，則不在保修範圍之內。不在保修範圍的情況包括但不限於，使用改裝燈泡和修改電路等被視為誤用或濫用而損壞產品的行為。

間接及附帶損害免費聲明:

Maxspect 對您或其他使用者的間接或附帶損害不承擔責任。間接或附帶損害包括但不限於，使用產品造成的損失或不便，對個人財產造成的損失，如電話，收入損失或盈利損失。本質保書賦予您合法權利，在不同的地區您還可能享有其它權利。

除上面明確提出的內容外，Maxspect 公司對產品的質量，性能，適銷性或特別用途的適用性均沒有作出明示或暗示的擔保或陳述。因此，本產品“按現狀”提供，您作為購買者承擔有關此產品的質量和性能的全部風險。

在任何情況下，Maxspect 公司均不對因本產品或其文件的缺陷而引起的直接的、間接的、特別的、附帶的或結果性的損害承擔責任。

上述質保書，聲明和故障排除方法是唯一版本，沒有其它口頭的或書面的，明示的或暗示的內容。在任何時候，Maxspect 公司的經銷商，代理商或雇員都無權對此質保書進行更改、擴展或補充。

由於某些地區不允許此類附帶性或結果性損害的免責或有限責任，上述限制可能不適用於您。

預設 1

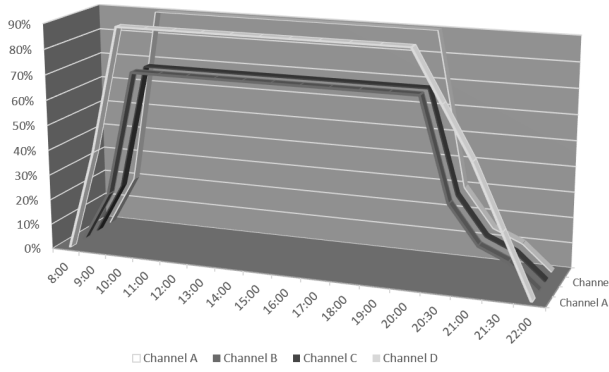

預設 2

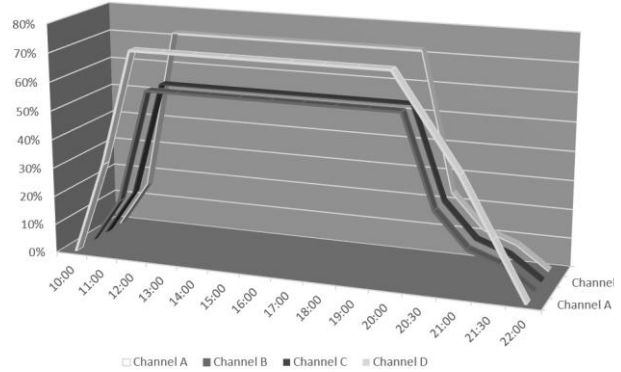

預設 3

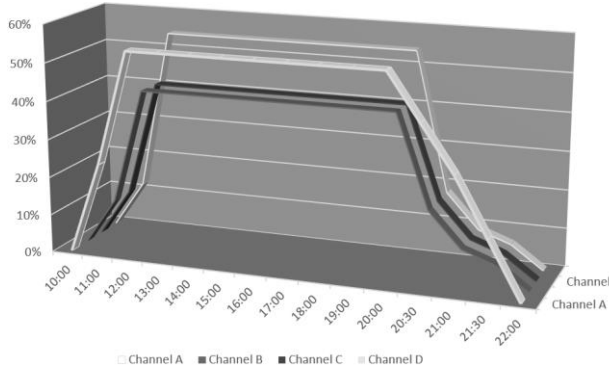

預設 4

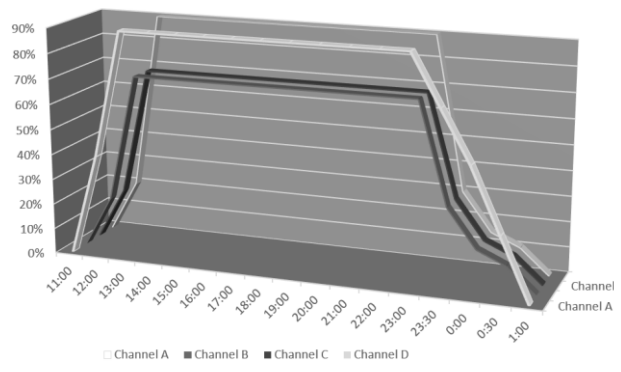

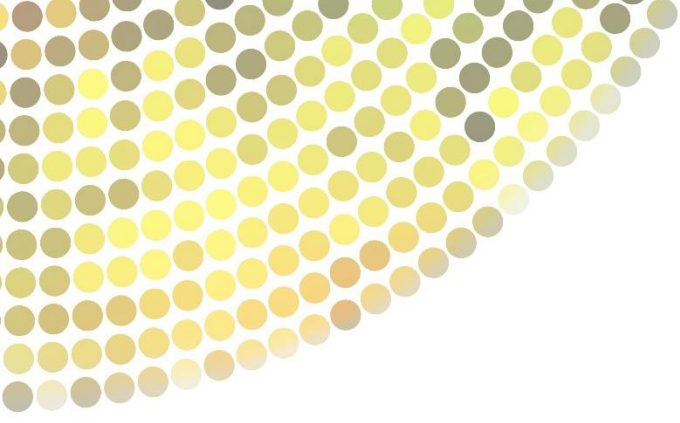

www.maxspect.com

NOTE: Products, packaging, features and specifications are subject to change.

All screen images are simulated.

© 2009-2017 Maxspect Limited. Reproduction in whole or in part without written permission is prohibited. All rights reserved. Maxspect is trademark of Maxspect Limited.

Maxspect™ RSX Owner's Manual Version 1.0

